



**Instructions for use**



**VIDEO** *Plus+*

*Let's make things better.*



**PHILIPS**

# General information

## Laser safety

This unit employs a laser. To prevent possible eye injury, only a qualified service person should remove the cover or attempt to service this device.

**USE OF CONTROLS OR ADJUSTMENTS OR PERFORMANCE OF PROCEDURES OTHER THAN THOSE SPECIFIED HEREIN MAY RESULT IN HAZARDOUS RADIATION EXPOSURE.**

### LASER

Type	InGaAlP semiconductor laser (DVD) AlGaAs semiconductor laser (CD)
Wavelength	660 nm (DVD) 780 nm (CD)
Output Power (out of objective)	20 mW (DVD writing) 0.8 mW (DVD reading) 0.3 mW (CD reading)
Beam divergence	82 degrees (DVD) 54 degrees (CD)

**CLASS 1  
LASER PRODUCT**

WARNING LOCATION: INSIDE ON LASER COVERSHEILD

**CAUTION** VISIBLE AND INVISIBLE LASER RADIATION. WHEN OPEN AVOID EXPOSURE TO BEAM  
**ADVARSEL** SYNLIG OG USYNLIG LASERSTRÅLING VED ÅBNING  
UNNGÅ UDSÆTTELSE FOR STRÅLING  
**ADVARSEL** SYNLIG OG USYNLIG LASERSTRÅLING NÅR DEKSEL ÅPNES  
UNNGÅ EKSPONERING FOR STRÅLEN  
**VARNING** SYNLIG OCH OSYNLIG LASERSTRÅLNING NÅR DENNA DEL  
ÄR ÖPPNAD BETRakta EJ STRÅLEN  
**VARO!** AVATTAESSA OLET ALTTIINA NÄKYVÄLLE JA  
NÄKYMÄTTÖMÄLLE LASER SÄTEILYLLE. ÄLÄ KATSO SÄTEESEEN  
**VORSICHT** SICHTBARE UND UNSICHTBARE LASERSTRAHLUNG  
WENN ABDECKUNG GEÖFFNET NICHT DEM STRAHL AUSSETZEN  
**DANGER** VISIBLE AND INVISIBLE LASER RADIATION. WHEN OPEN  
AVOID DIRECT EXPOSURE TO BEAM  
**ATTENTION** RAYONNEMENT LASER VISIBLE ET INVISIBLE EN CAS  
D'OUVERTURE EXPOSITION DANGEREUSE AU FAISCEAU

**NEVER MAKE OR CHANGE CONNECTIONS WITH THE POWER SWITCHED ON.**



The DVD recorder is in conformity with the EMC directive and low-voltage directive.

**CAUTION** ONLY QUALIFIED SERVICE PERSONNEL SHOULD REMOVE THE COVER OR ATTEMPT TO SERVICE THIS DEVICE.

### For Customer Use:

Read carefully the information located on the back of your DVD recorder and entered below the Serial N°. Retain this information for future reference.

Model N°. DVDR985

Serial N°. \_\_\_\_\_

**VIDEO Plus+**

“VIDEO Plus+” and “PlusCode” are registered trademarks of the Gemstar Development Corporation. The Video Plus+ system is manufactured under licence from Gemstar Development Corporation.

Manufactured under license from Dolby Laboratories. “Dolby”, “Pro Logic” and the double-D symbol are trademarks of Dolby Laboratories. Confidential Unpublished Works. ©1992-1997 Dolby Laboratories, Inc. All rights reserved.

This product incorporates copyright protection technology that is protected by method claims of certain U.S. patents and other intellectual property rights owned by Macrovision Corporation and other rights owners. Use of this copyright protection technology must be authorized by Macrovision Corporation, and is intended for home and other limited viewing uses only unless otherwise authorized by Macrovision Corporation. Reverse engineering or disassembly is prohibited.

TRUSURROUND, **SRS**, and symbol  are trademarks of SRS Labs, Inc. TRUSURROUND technology is manufactured under license from SRS Labs, Inc.

---

## Introduction

DVD Video Recorder	6
Box contents	7
Placement	7
Cleaning discs	7
Remote control	7
Loading the batteries	7

---

## Installation

Connections - back side of your DVD recorder	8
Connecting to the antenna	8
Connecting to a TV set	8
S-video (Y/C) connection	8
Video (CVBS) connection	8
Connecting to audio equipment	9
Connecting to A/V receiver or A/V amplifier with digital Multi-channel decoder	9
Connecting to a receiver equipped with two channel digital stereo (PCM)	9
Connecting to a receiver equipped with Dolby Pro Logic	9
Connecting to a TV set equipped with a Dolby Pro Logic decoder	9
Connecting to a receiver with two channel analogue stereo	9
Connecting to other equipment	10
Connections - frontside of your DVD recorder	10
Camcorder connection	10
Power supply	11
Switching on	11
First time set-up: virgin mode	11
Automatic setting	11
Manual setting	12

---

## Functional overview

Front of recorder	14
Rear of recorder	15
Display	16
Remote control	17

---

## Operation

Important notes for operation	18
Loading discs	18
Disc types	18
The following disc types can be used for recording and playback	18
The following disc types can be used for playback only	18
The following disc types cannot be used at all, neither for recording nor for playback	19
On-screen display information	19
System menu bar	19
User preference menu operation	20
Status box	20
Tuner info box	21
Timer info box	21
Warning box	21
Index Picture Screen	22
User preferences	23
Setting user preferences	23
Picture settings	23
Sound settings	23

Language settings	24
Feature settings	24
Remote control settings	25
Record settings	25
Installation	26

---

## Recording

Before you start recording	28
Manual recording	28
Checking input	28
Recording	28
Manual audio control	29
Recording with automatic switch-off (OTR One-Touch Recording)	30
Timer programming	30
Timer programming with the VIDEO Plus+® system	30
Timer programming without the VIDEO Plus+ system	31
Programming with 'NEXTVIEW Link'	32
If a timer setting is incorrect	32
How to check or alter a timer block	33
How to clear a timer block	33

---

## Playback

Playing a DVD+RW or DVD+R disc	34
Playing a pre-recorded DVD-Video disc	34
Playing a (Super) Video CD disc	34
General features	35
Moving to another title/track	35
Moving to another chapter/index	35
Slow Motion	35
Still Picture and Step Frame	36
Search	36
Repeat	36
Repeat A-B	36
Scan	37
Time search	37
Zoom	37
Special DVD+R(W) features	38
Recording date and time	38
Special DVD-Video features	38
Menus on the disc	38
Camera Angle	38
Changing the audio language	38
Subtitles	39
Special VCD-Features	39
Playback Control (PBC)	39
Playing an audio CD	39
Pause	40
Search	40
Moving to another track	40
Repeat track/disc	40
Repeat A-B	40
Scan	40

---

**Access control**

Child Lock (DVD and VCD) _____	41
Activating/deactivating the child lock _____	41
Authorizing discs when Child Lock is activated _____	41
Securing discs _____	41
Parental Level (DVD-Video only) _____	42
Activating/Deactivating Parental Control _____	42
Country _____	42
Changing the 4-digit code _____	43

---

**Managing disc content**

Title settings _____	44
Changing the title name _____	44
Play full title _____	44
Erasing a title _____	44
Disc Info Screen _____	44
Disc Settings _____	45
Changing the Disc Name _____	45
Protection of recordings _____	45
Erasing a disc _____	45
Finalising a DVD+R disc _____	45
Making your edits DVD compatible _____	46
Favourite Scene Selection _____	46
Calling up the FSS menu _____	46
Inserting chapter markers _____	47
Hiding chapters _____	47
Deleting chapter markers _____	47
Changing the index picture _____	47
Dividing a title _____	48
Append recording _____	48

---

**Troubleshooting**

Troubleshooting checklist _____	49
Diagnosis programme _____	51
Instructions _____	51
System limitations _____	51

---

**Glossary**

---

**Appendix**

Using your DVD recorder remote control with your TV set _____	54
---	----

# Introduction

## DVD Video Recorder

DVD (Digital Versatile Disc) is the new storage medium that combines the convenience of the Compact Disc with the latest advanced digital video technology. DVD-Video uses state-of-the-art MPEG2 data compression technology to register an entire movie on a single 5-inch disc. DVD's variable bitrate compression, running at up to 9.8 Mbits/second, captures even the most complex pictures in their original quality. The crystal-clear digital pictures have a horizontal resolution of over 500 lines, with 720 pixels (picture elements) to each line. This resolution is more than double that of VHS, superior to Laser Disc, and entirely comparable with digital masters made in recording studios.

DVD recording is the next step in video technology. DVD+ReWritable (DVD+RW) uses phase-change media, the same technology that formed the basis for CD-ReWritable. A high-power laser is used to change the reflectivity of the recording layer. This process can be repeated more than a thousand times. DVD+Recordable (DVD+R) uses discs based on an organic dye, a technology pioneered with the successful CD-Recordable format, to produce discs that keep your data for a lifetime.

Your Philips DVD recorder is a **recorder** and **player** for digital video discs, with a **two-way compatibility** to the universal DVD-Video standard. This means that:

- existing **pre-recorded DVD-Video** discs can be played on your Philips DVD recorder and
- **recordings**, made on your Philips DVD recorder, can be played on most DVD-Video players and DVD-ROM drives.

With it, you will be able to record TV programmes or to edit and archive your own camcorder recordings. Superb digital picture and sound quality, quick access to the tracks you have recorded and extensive playback features contribute to a completely new video experience.

From now on you will enjoy full-length movies with true cinema picture quality, and stereo or Multi-channel sound (depending on the disc, and on your playback set-up). You will find your recorder remarkably easy to use, by way of the On-Screen Display on your TV and the display on the DVD recorder, in combination with the remote control.

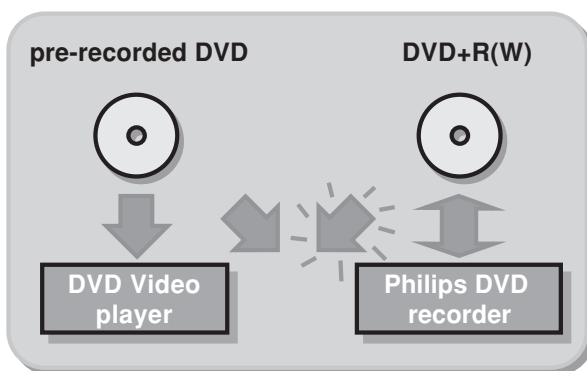

## Box contents

First check and identify the contents of your DVD recorder package, as listed below:

- DVD recorder
- Remote Control Handset with separately-packed batteries
- 2-core power cord
- SCART cable
- S-video cable
- Antenna (aerial) cable
- Audio cable
- Video cable
- DVD+RW disc
- User Manual
- Warranty card

If any item should be damaged or missing, please inform your supplier without delay.

Keep the packaging materials; you may need them to transport your recorder in the future.

## Placement

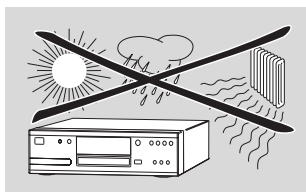

- Place the recorder on a firm, flat surface.
- Keep away from domestic heating equipment and direct sunlight.
- In a cabinet, allow about 2.5 cm (1 inch) of free space all around the recorder for adequate ventilation.
- The lense may cloud over when the DVD recorder is suddenly moved from cold to warm surroundings. Playing a CD/DVD is not possible then. Leave the DVD recorder in a warm environment for two hours before use, so the moisture can evaporate.
- The recorder should not be exposed to dripping or splashing, no objects filled with liquids, such as vases, should be placed on the recorder.

## Cleaning discs

Some problems may occur because the disc inside the recorder is dirty. To avoid these problems clean your discs regularly, in the following way:

- When a disc becomes dirty, clean it with a cleaning cloth. Wipe the disc from the centre out.

### Caution:

**Do not use solvents such as benzine, thinner, commercially available cleaners, or anti-static spray intended for analogue discs.**

**Do not use commercially available cleaning discs to clean the lens, as these discs may damage the optical unit.**

## Remote control

### Loading the batteries

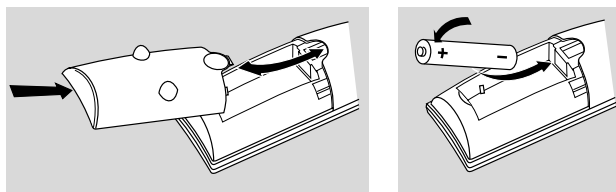

- Open the battery compartment cover.
- Insert two 'AA' (LR-6) batteries as indicated inside the battery compartment.
- Close the cover.

### Caution:

**Do not mix old and new batteries. Never mix different types of batteries (standard, alkaline, etc.). This may reduce the lifetime of the batteries.**

# Installation

## Connections - back side of your DVD recorder

- Please refer to your TV set, VCR, Stereo System and any other User Manual(s) as necessary to make the optimal connections.
- Do not connect the power until all other connections are made.
- Do not connect your DVD recorder to your TV set via your VCR, because the video quality could be distorted by the copy protection system.
- For better sound reproduction you can connect the recorder audio outputs to your amplifier, receiver, stereo system or A/V equipment. For this see 'Connecting to A/V receiver or A/V amplifier'.

### Caution:

**Do not connect the recorder's audio output to the phono input of your audio system in order to avoid damage to your equipment.**

## Connecting to the antenna

- Remove the antenna (aerial) cable plug from your TV set and insert it into the antenna socket at the back of the DVD recorder.
- Plug one end of the antenna (aerial) cable supplied (1) into the TV socket on the DVD recorder and the other end into the antenna input socket on your TV set.

## Connecting to a TV set

To obtain the highest possible picture and sound quality from your TV set it is recommended to use the SCART connector on both DVD recorder and TV set.

- Connect the bottom SCART connector (EXT 1) to the TV set, using the SCART cable supplied (2) as shown in the drawing. If your TV set is equipped with EasyLink or Cinema Link, make sure you use the correct scart connector. For this refer to the user manual of your TV set.

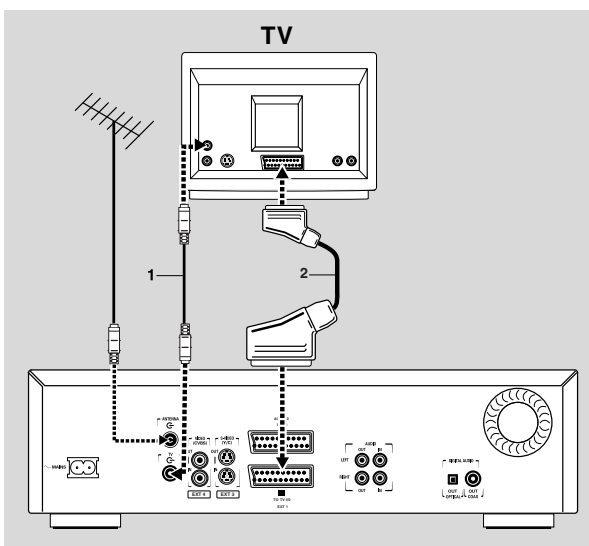

If your TV set is not equipped with a SCART connector, you can connect the DVD recorder with the S-video (Y/C) sockets.

## S-video (Y/C) connection

- Connect the S-video output socket to the corresponding input socket on the TV set, using the supplied S-video cable (3).
- Connect the audio Left (white) and Right (red) output sockets to the corresponding sockets on the TV set using the audio cable supplied (5).

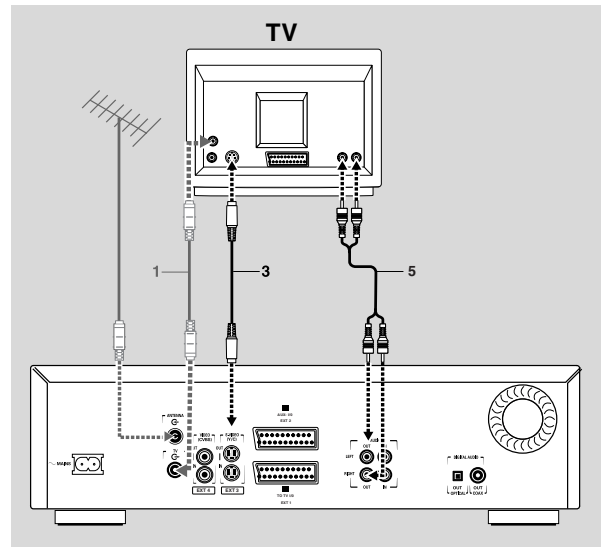

If your TV set is not equipped with S-video sockets, then connect the DVD recorder with the CVBS sockets to your TV set.

## Video (CVBS) connection

- Connect the Video (CVBS) output socket (yellow) to the corresponding input socket on the TV set using the video cable supplied (4).
- Connect the audio Left (white) and Right (red) output sockets to the corresponding sockets on the TV set using the audio cable supplied (5).

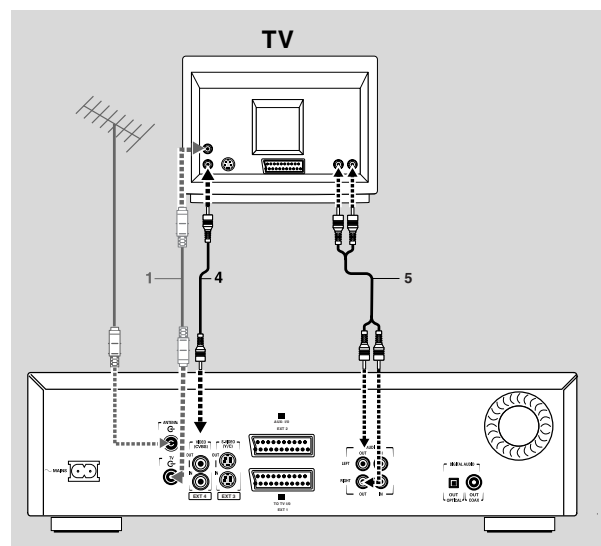



## Connecting to audio equipment

### Connecting to A/V receiver or A/V amplifier with digital Multi-channel decoder

The best possible sound quality is obtained by connecting your DVD recorder to an A/V receiver with Multi-channel decoder (Dolby Digital, MPEG 2 and DTS).

#### Digital Multi-channel sound

Digital Multi-channel connection provides the optimum sound quality. For this you need a Multi-channel A/V receiver that supports one or more of the audio types supported by your DVD recorder (MPEG 2, Dolby Digital and DTS). For this you can check the receiver manual and the logos on the front of the receiver.

- Connect the recorder's digital audio output to the corresponding input on the receiver. Use a digital coaxial cable (7) or a digital optical audio cable (8).

If you do not own a digital coaxial audio cable (not supplied), you may use the supplied video cable (4).

#### Note:

If the audio type of the digital output does not match the capabilities of your receiver, the receiver will produce a strong, distorted sound. The audio type of the DVD disc in play is displayed in the Status Window, when changing the language. 6 Channel Digital Surround Sound via digital connection can only be obtained if your receiver is equipped with a Digital Multi-channel decoder.

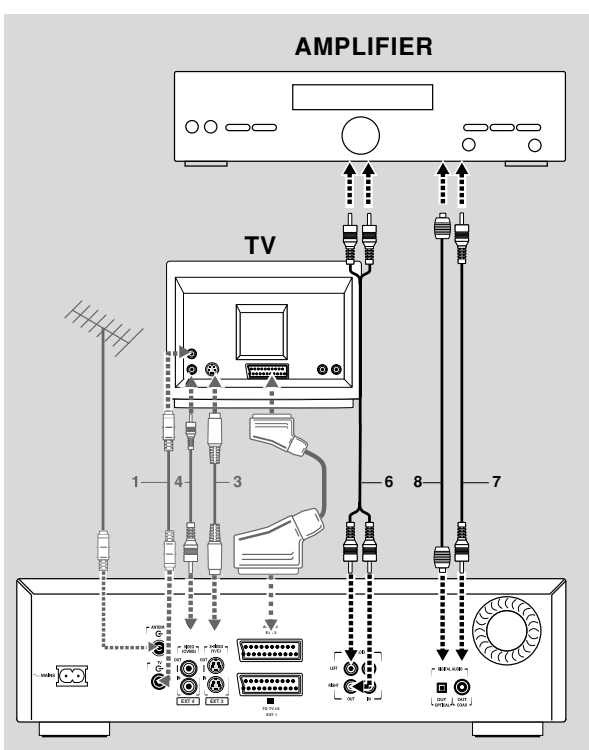

If you cannot connect your DVD recorder to an A/V receiver with Multi-channel decoder, choose one of the following alternatives.

### Connecting to a receiver equipped with two channel digital stereo (PCM)

- Connect the recorder's digital audio output to the corresponding input on your receiver. Use the supplied video (CVBS) cable (7) or an optional digital optical audio cable (8).
- After installation you will need to activate PCM on the DVD recorder's digital output (see 'User Preferences').

### Connecting to a receiver equipped with Dolby Pro Logic

- Connect the recorder to the TV set and connect the recorder's audio Left and Right output sockets to the corresponding inputs on the Dolby Pro Logic Audio/Video receiver, using the audio cable supplied (6).

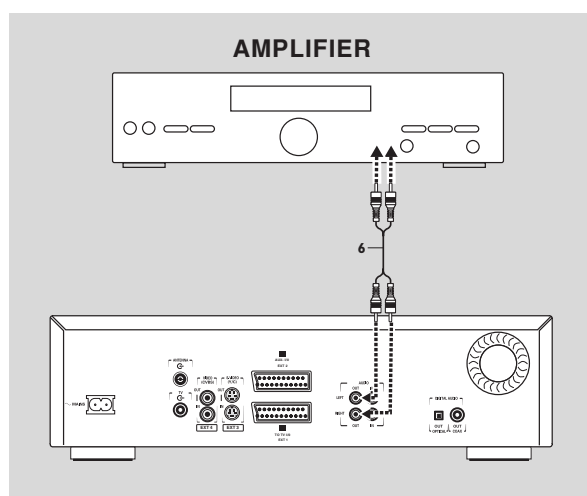

- Make the appropriate Sound settings for Analogue Output in the user preferences menu.

### Connecting to a TV set equipped with a Dolby Pro Logic decoder

- Connect the recorder to the TV set as described in chapter 'Connecting to a TV set'.

### Connecting to a receiver with two channel analogue stereo

- If you have a receiver with two-channel analogue stereo without any of the above mentioned sound systems, connect the audio Left and Right output sockets to the corresponding sockets on your receiver, amplifier or stereo system. Use the audio cable supplied (6).

## Connecting to other equipment

Use the top SCART connector (EXT 2) on your DVD recorder to make connections to a:

- Satellite receiver or Set top box,
- VCR,
- DVD-Video player

Most pre-recorded video cassettes and DVD discs are copy protected. If you try to copy them the display shows 'COPY PROTECT'.

For installation of a decoder, see 'User Preferences' - 'Installation'.

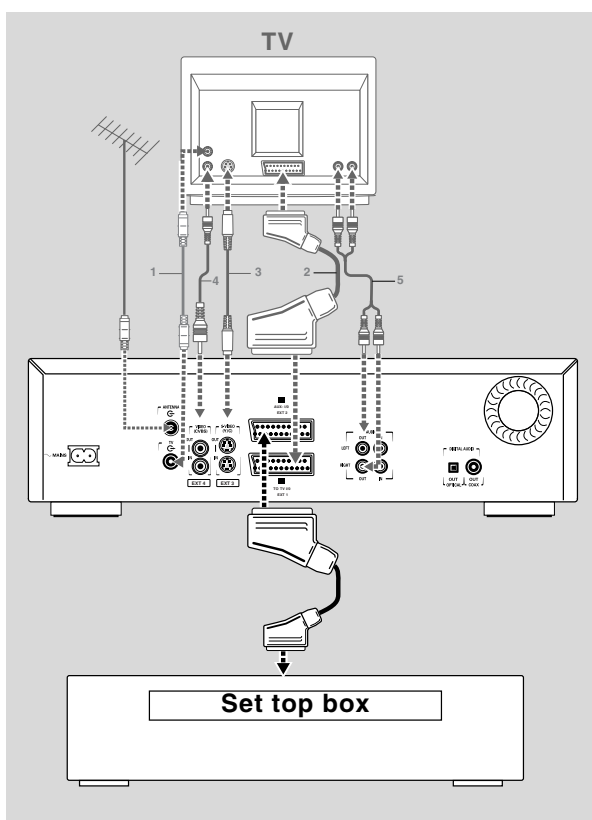

**Notes:**

- If the power is off or Low Power Standby is selected (see User Preferences - features), the signal from EXT 2 will not be passed on to the TV set on EXT 1.
- EasyLink functionality will not be available to devices connected via the DVD recorder's EXT 2 SCART connector.

## Connections - frontside of your DVD recorder

### Camcorder connection

- If you have a DV or Digital 8 camcorder, connect the i-link DV input socket (1) to the corresponding output socket on the camcorder using the i-link cable of your camcorder.
- If you have a Hi-8 or S-VHS(C) camcorder, connect the S-video input socket to the corresponding output socket on the camcorder, using the S-video cable supplied (2) and connect the audio cable (4) supplied.
- Otherwise connect the Video input socket (yellow) to the corresponding output socket on the camcorder using the video cable supplied (3) and connect the audio Left (white) and Right (red) input sockets to the corresponding sockets on the camcorder using the audio cable supplied (4).
- If your camcorder has mono sound, use only the left audio connector. In this case the sound will be recorded on both audio channels.

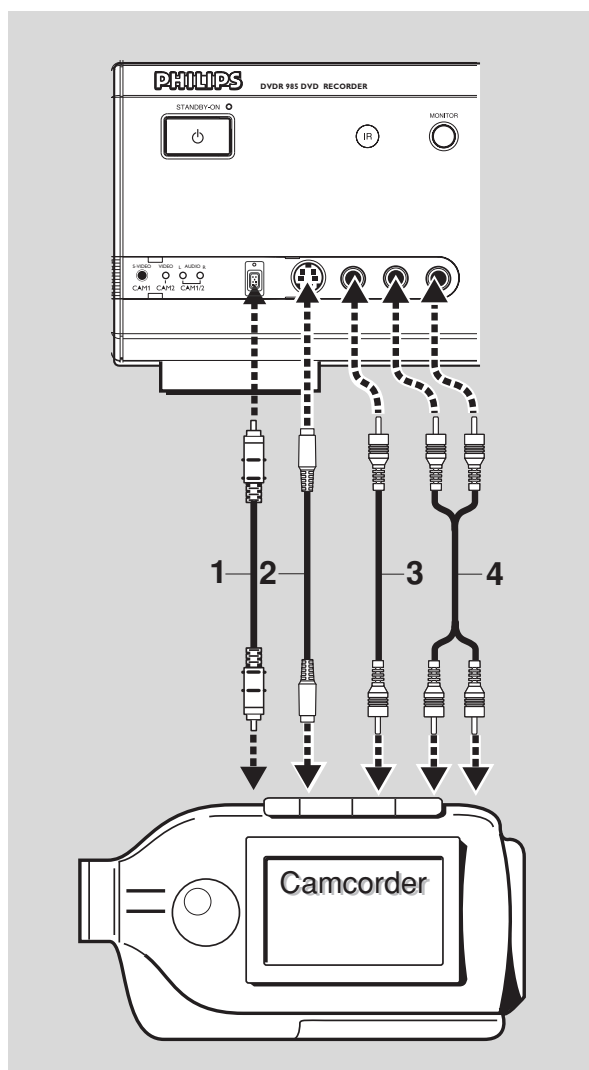

## Power supply

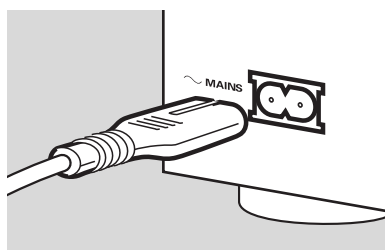

- Make sure that all necessary connections are made before connecting the DVD recorder to the power supply.
- Plug the power cable supplied into the Power connector on the rear of the recorder.
- Plug the mains plug into an AC outlet.

### Note:

Always check if the local mains voltage matches the required 220V - 240V.

When the recorder is in the Standby position, it is still consuming some power.

If you wish to disconnect your DVD recorder completely from the mains, withdraw the plug from the AC Outlet.

When the DVD recorder is disconnected from the mains, TV channels and timer data will be stored typically 1 year.

## Switching on

- Switch on the TV set and select the programme number that you have chosen for video playback (see operating manual for your TV set).
- Press **STANDBY/ON**.
  - The recorder display lights up. If you have not yet installed your DVD recorder, it will enter 'virgin mode'. In this mode you will have to set your personal preferences.

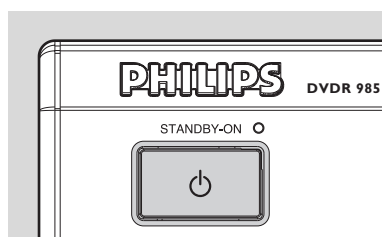

## First time set-up: virgin mode

After switching on the DVD recorder for the very first time the 'virgin mode screen' will appear.

In 'virgin mode' you may have to set your preferences for some of the recorder features.

If the 'virgin mode screen' does not appear, your DVD recorder has been installed already. You may still change the settings via the 'installation menu'.

Depending on the kind of TV set, preferences will have to be set manually or they will be taken over automatically from the TV set.

### Automatic setting

When your TV set is equipped with EasyLink™, Cinema Link™, NEXTVIEW Link™, SmartLink™, Q-Link™ or MegaLogic™, the TV settings will be taken over from the TV set but they cannot be changed manually afterwards.

When preferences are taken over from your TV set, the message 'Easy Link loading data from TV-please wait' will appear.

Menus for which no preferences are available will be displayed. They have to be set manually.

### Note:

Preferences have to be set in the order in which the item menus will appear on the screen.

If the recorder is switched off while setting user preferences, all preferences have to be set again after switching the recorder on again.

The 'virgin mode' will only be concluded after the preferences for the last item have been confirmed.

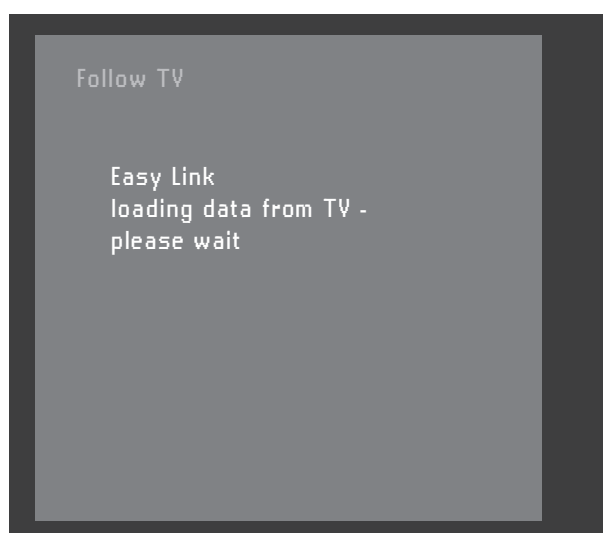

## Manual setting

When a menu is displayed:

- Use the  $\nabla/\Delta$  (down/up cursor) keys to go through the options in the menu. The icon of the selected option will be highlighted.
- Use **OK** to confirm your selection and to select the next menu.

The following items may have to be set in virgin mode:

### Menu language

The on-screen menus of DVD-Video discs will be displayed in the language you choose.

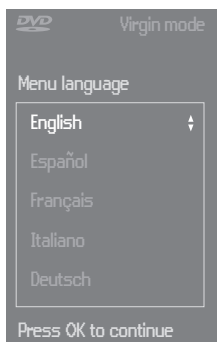

### Audio language

The sound of DVD-Video discs will be in the language you choose, provided this is available on the disc in play. If not, speech will revert to the first spoken language on the disc. Also the DVD-Video disc menu will be in the language you choose, provided this is available on the disc.



### Subtitle language

The subtitles of DVD-Video discs will be in the language you choose provided this is available on the disc in play. If not, subtitles will revert to the first subtitle language on the disc.



## TV Shape



You can choose:

- **16:9** if you have a wide screen (16:9) TV set.
- **4:3** if you have a regular (4:3) TV set. In this case you can also choose between:
  - **Letterbox** for a 'wide-screen' picture with black bars at the top and bottom,
  - **Pan Scan**, for a full-height picture with the sides trimmed. If a disc has Pan Scan, the picture then moves (pans) horizontally to keep the main action on the screen.

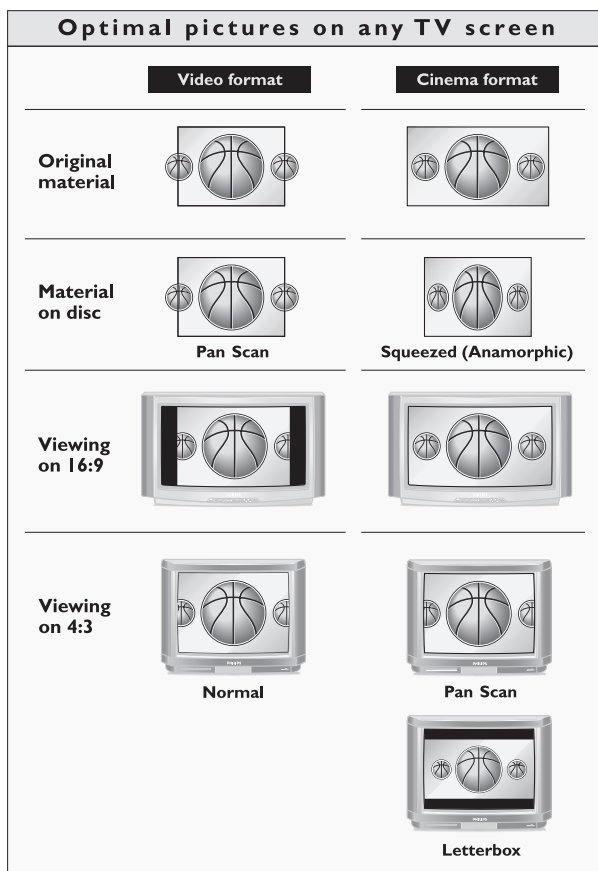

## Country

Select your country. This is used as input for the 'Parental Control' feature (see 'Access Control') as well as the searching of TV channels.

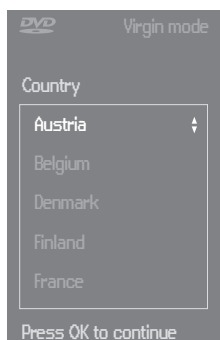

## Auto TV Channel Search

Make sure the antenna is connected. See 'Connecting to the antenna'. Your DVD recorder will search for all TV channels.

It stores channels in the sequence they are found.

- Confirm with **OK**.
  - Auto search starts. This can take several minutes.

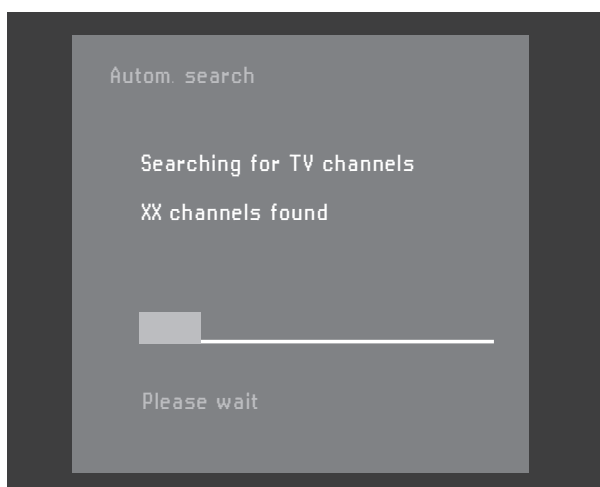

- When Auto search is completed '**Autom search complete - XX channels found**' appears on the TV screen.

After Auto channel search you can have TV channels stored automatically in the same order as your TV set. See 'User preferences installation' - 'Follow TV'.

## Time/Date

When Channel auto search is completed the actual Time and Date are also set automatically.

If the time in the DVD recorder display is not correct, the clock must be set manually.



- Adjust 'Time', 'Year', 'Month', 'Date' if required, with the ▾ (down cursor) or ▴ (up cursor) key.
- Change values with the the ◀ (left cursor) or ▶ (right cursor) key or the digit keys **0-9**.
- To end, press **OK**.

### Note:

*All these items may have to be set after first start up ('virgin mode'). After that they can always be adapted in the user preferences menu. When your TV set is equipped with EasyLink the TV set presets will be taken over from the TV set but they cannot be changed manually afterwards.*

Virgin mode settings are now completed.

All settings can still be changed. See 'User preferences'.

# Functional overview

English

## Front of recorder

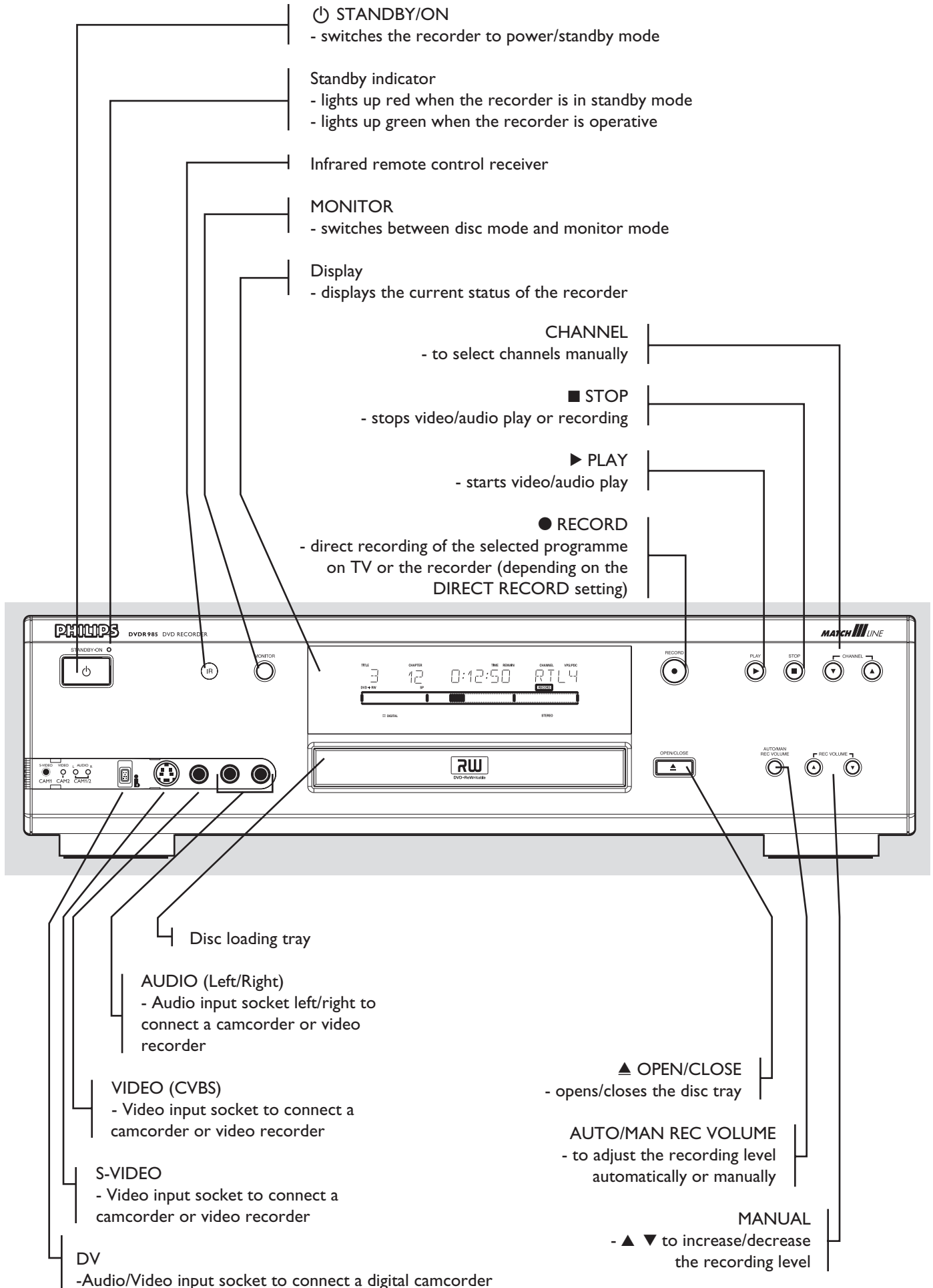

## Rear of recorder

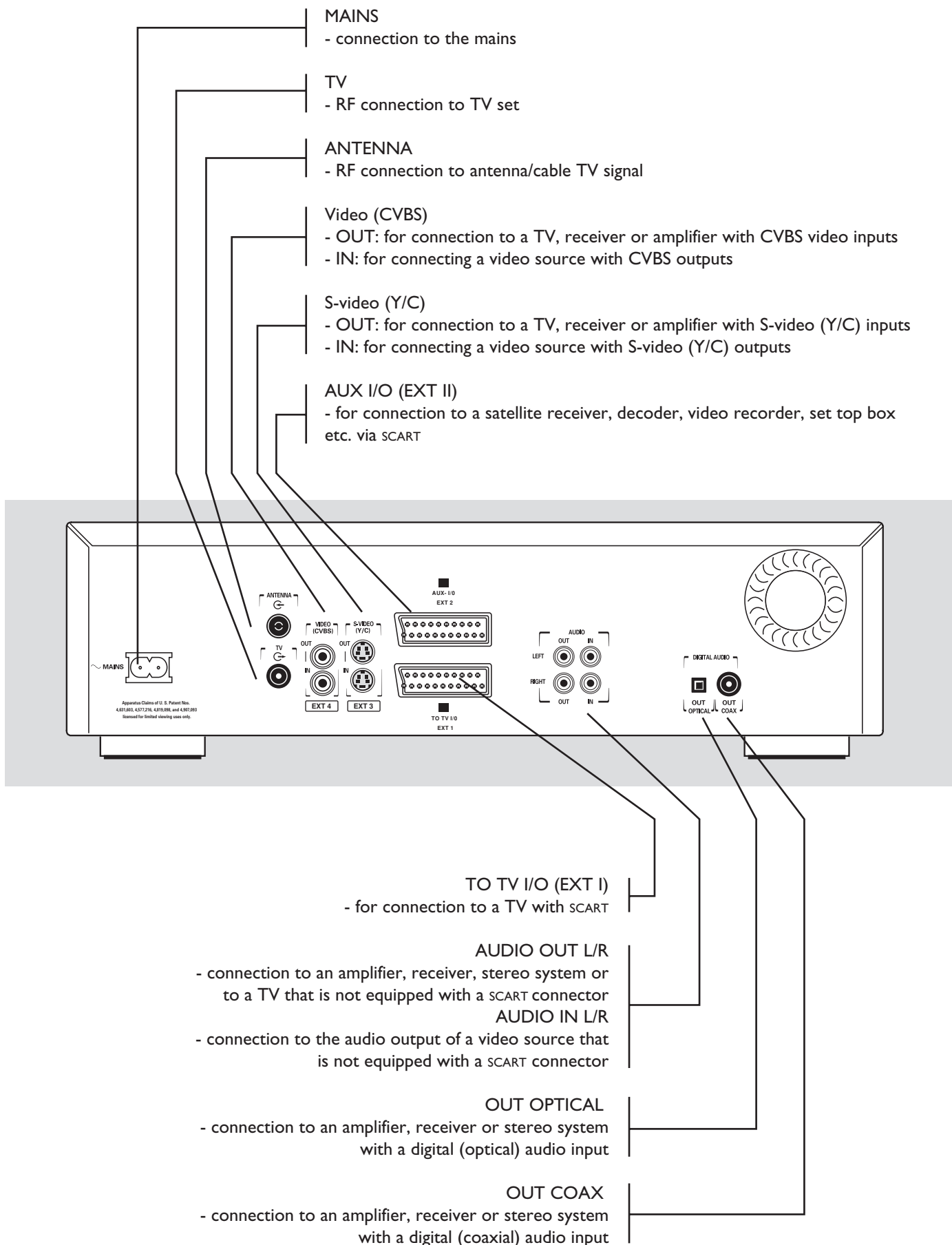

# Display

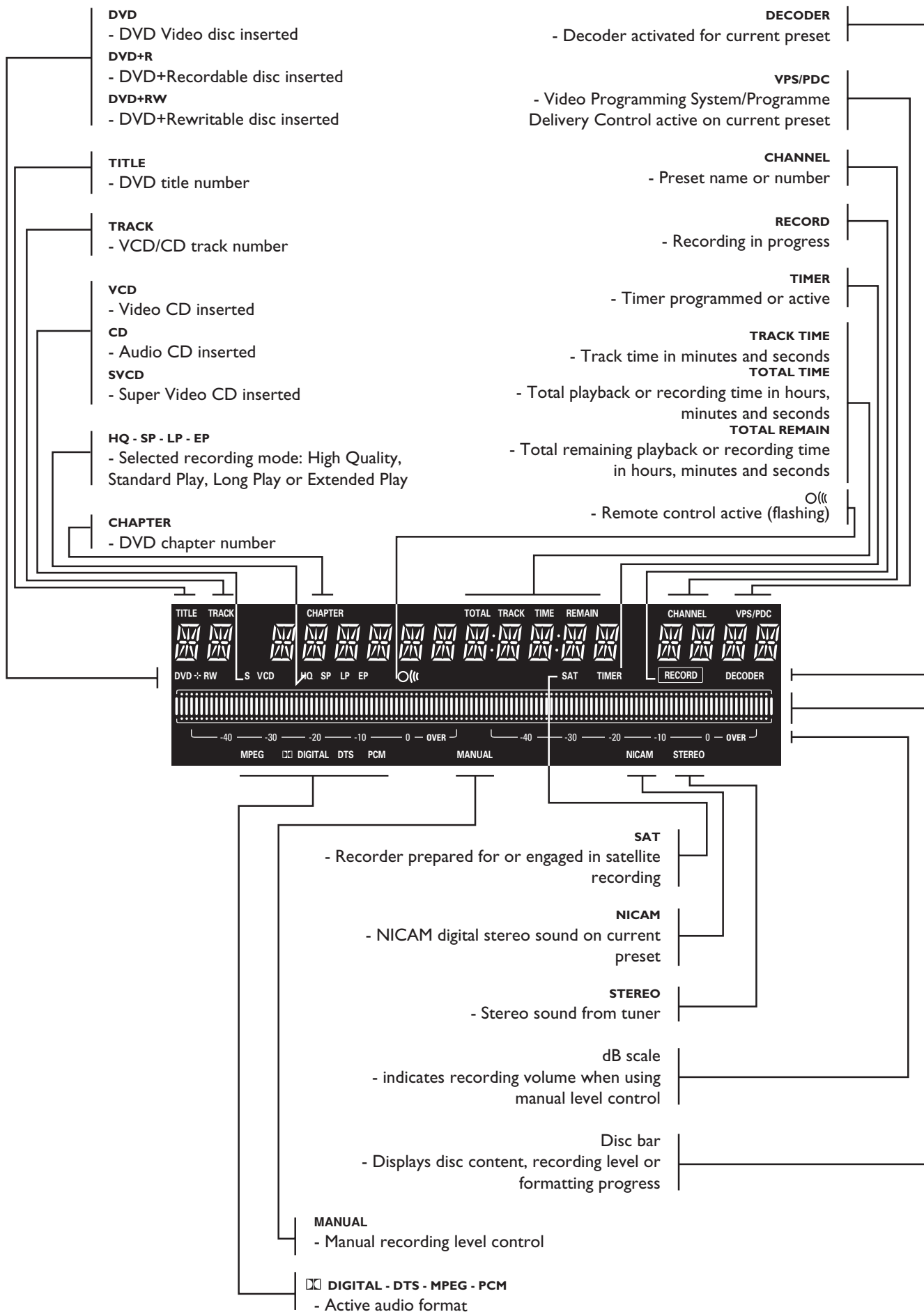



## Remote control

### MONITOR

- switches between disc mode and monitor mode

- ◀
- previous chapter, track or title
- 
- direct recording of the currently selected programme
- ▶
- next chapter, track or title
- ◀◀
- search backward
- ⏸
- pause
- ◀▶
- slow motion
- ▶▶
- search forward
- 
- stop
- ✂ **FSS**
- displays Favorite Scene Selection menu for DVD+RW or DVD+R disc
- ▶
- play

### VOL +/-

- TV volume up/down

- 🔇
- TV Mute ON/OFF

### CH +/-

- programme up/down

### 🔍 ZOOM

- enlarge video image

### 📷 ANGLE

- select DVD camera angle

### 🗨 SUBTITLE

- subtitle language selector

### 🔊 AUDIO

- audio language selector

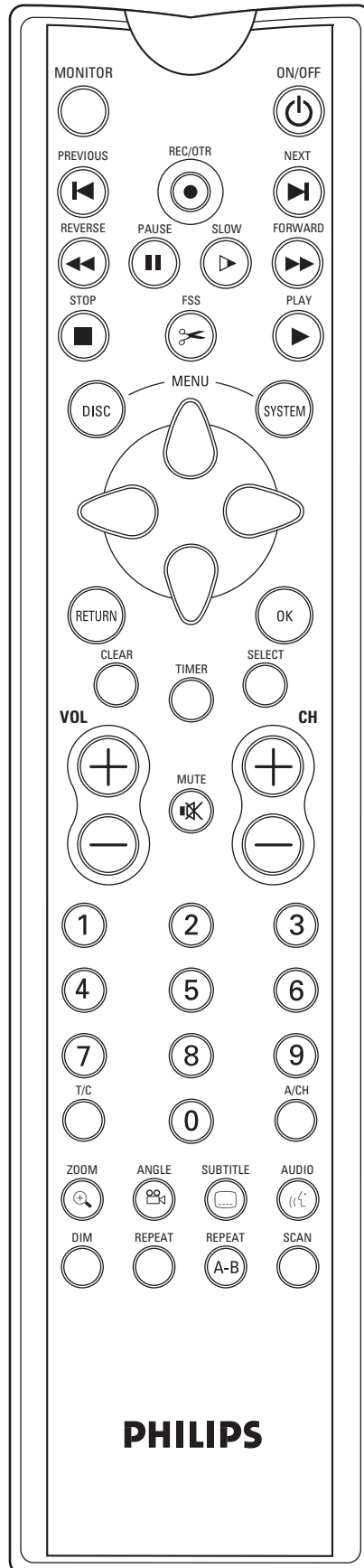

### ON/OFF

### DISC MENU

- displays DVD disc menu or index picture screen

### SYSTEM MENU

- displays recorder system menu bar

▽ ▲ ▷ ◀

- down/up/right/left cursor movement

### RETURN

- return to previous menu on (S)VCD disc

### CLEAR

- delete last entry/clear timer

### TIMER

- displays the 'timer menu'

### SELECT

- switches between different values in a menu
- switches between record modes in the Index Picture Screen and in monitor mode

### OK

- acknowledge menu selection

### 0-9

- numerical key pad

### T/C

- select title
- select chapter

### A/CH Alternate Channel

- switches to the previous TV channel

### SIDE SWITCH

- enables other keys to operate the TV set (see Appendix)

### DIM

- changes brightness setting of display

### REPEAT

- repeat chapter, track, title, disc

### REPEAT A-B

- repeat sequence

### SCAN

- playback of the first 10 seconds of each chapter within a title (DVD) or the first 10 seconds of each track on a disc (VCD/CD)

# Operation

## Important notes for operation

You can switch on the DVD recorder with the **STANDBY/ON** key. Keep your DVD recorder connected to the mains at all times to ensure that programmed recordings can be made and that the television functions normally.

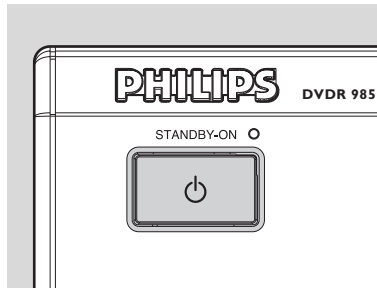

Both the DVD recorder and the remote control have an 'Emergency interrupt' button. You can use the **STANDBY/ON** button to interrupt a function. When you have an operating problem, you can interrupt the function and start again.



When you switch off the DVD recorder, the display will briefly show 'WAIT'.

## Loading discs

- 1 Press **▲ OPEN/CLOSE** on the front of the recorder. The disc loading tray opens.
- 2 Lay your chosen disc in the tray, label side up. Make sure it is sitting properly in the correct recess.
- 3 Press **/ Open/Close**, to close the tray.
  - ▶ 'READING' appears in the status box and on the recorder display. If the inserted disc is pre-recorded or write-protected, playback always starts automatically.

You can always unload a disc by pressing **▲ OPEN/CLOSE** again or pressing **■ STOP** on the remote control for two seconds.

Note:

If 'Child Lock' is set to ON and the disc inserted is not in the 'child safe' list (not authorized), the PIN code must be entered and/or the disc has to be authorized. (see 'Access Control')

## Disc types

You will recognize the different types of discs, that can be used in your DVD recorder by the logo. Depending on the disc type you can either use it for recording and playback or playback only. Some discs are not suitable at all to be used in the DVD recorder.

In the next table a summary is given of all existing disc types and their DVD recorder compatibility.

### The following disc types can be used for recording and playback:

#### DVD+RW

Records and plays; In case of a new blank disc, after the first recording, some more time (up to two minutes) is needed to make the disc compatible with DVD-Video players.



#### DVD+R

Records and plays.



### The following disc type can be used for playback only:

#### DVD-Video



#### DVD-R

Only plays if it contains DVD-Video.



## DVD-RW

Only plays if it is recorded in Video mode and has been finalized.



## CD Digital Audio

You can play digital audio CDs in conventional style through a stereo system, using the keys on the remote control and/or front panel, or via the TV set using the on-screen display (OSD).



## Super Audio CD

Of hybrid SACD discs, the CD layer can be played.

## (Super) Video CD

Depending on the material on the disc (a movie, video clips, a drama series, etc.) these discs may have one or more tracks, and tracks may have one or more indexes, as indicated on the disc case. To make access easy and convenient, your recorder lets you move between tracks, and between indexes.



## CD-R/CD-RW

Plays if it contains Audio CD.



**The following disc types cannot be used at all, neither for recording nor for playback:**

## DVD-RAM



## DVD-Audio



## On-screen display information

### System menu bar

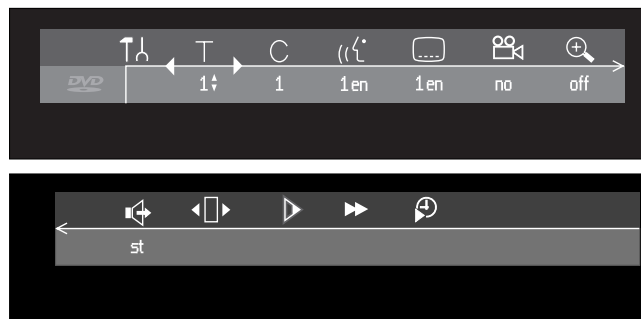

The system menu bar can be called up by pressing any of the following keys on the remote control: **SYSTEM MENU**, **T/C**, **ANGLE**, **SUBTITLE**, **AUDIO** and **ZOOM**.

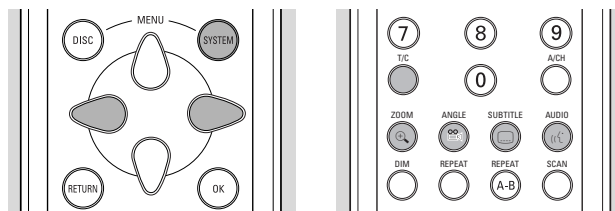

Widescreen (16:9) TV sets may show only part of the system menu bar in certain screen modes. Select a different screen mode on the TV to see the full menu. A number of recorder functions can be controlled via the system menu bar. You can navigate between the two parts of the system menu bar with the ◀ (left cursor) and the ▶ (right cursor) key.







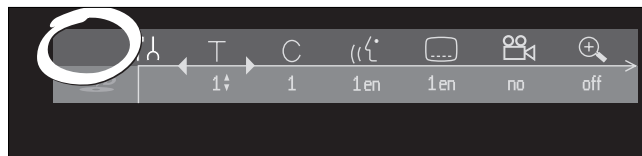





### System menu bar icons

PART 1	PART 2
User preference	Sound
Title/Track	Step motion
Chapter/Index	Slow motion
Audio language	Fast motion
Subtitle language	Time search
Angle	
Zoom	







### Temporary Feedback Field



The system menu bar contains a 'Temporary Feedback Field' with information concerning prohibited actions, playback modes, available angles, etc.

-  Scan
-  Repeat All
-  Repeat Title
-  Repeat Track
-  Repeat Chapter
-  Repeat A to end
-  Repeat A-B
-  Angle
-  Child Lock On
-  Child Safe
-  Resume
-  Action prohibited





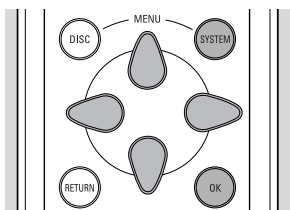

### User preference menu operation



- Press **SYSTEM MENU** on the remote control.
- Select  in the system menu bar and press  (down cursor).
  - The user preferences menu appears.
- Use the     (left right up down cursor) keys to toggle through the menus, sub menus and submenu options.
  - When a menu item is selected, the cursor keys (on the remote control) to operate the item are displayed next to the item.
- Press **OK** to confirm and return to the main menu.



The following functions can be operated via the user preference menu.

### User preference menu icons

-  Picture settings
-  Sound settings
-  Language settings
-  Feature settings
-  Remote control settings
-  Record settings
-  Installation

- You can navigate between the various items of the user preferences menu with the  (up cursor) and the  (down cursor) key. To select an item press  (right cursor) key.

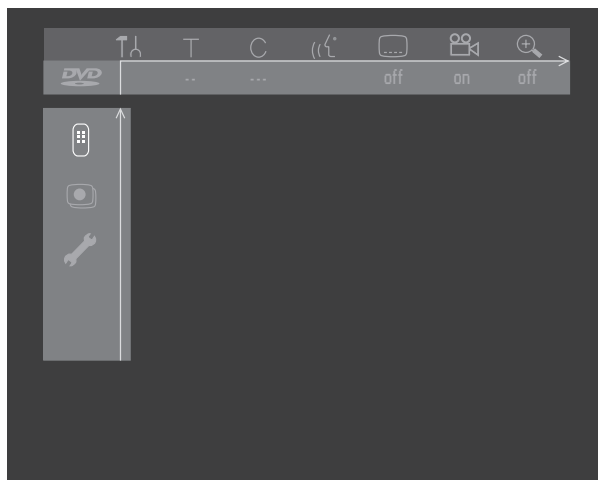
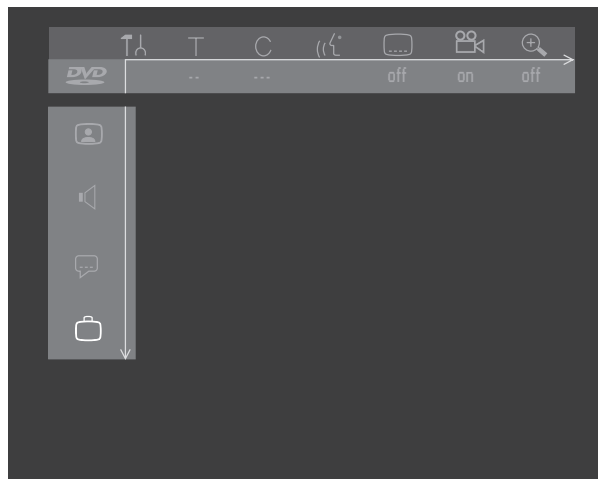

- By pressing **SYSTEM MENU** the system menu bar will disappear from the screen.

### Status box



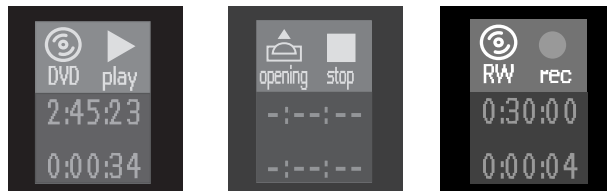





The status box on the left hand side of the screen displays the current status of the recorder and the disc type loaded for several seconds.



### Disc type icons

	DVD+RW
	DVD+R
	DVD-Video
	Super Video-CD
	Video-CD
	no disc
	disc error

### Disc status icons

	recording
	stop
	playing
	pause play
	record pause
	erasing
	fast forward
	fast reverse
	slow motion

### Tuner info box

The tuner info box is located at the bottom left of the screen and is displayed in monitor mode (See: Recording Checking input). It displays the currently selected input. When the tuner is selected it shows programme number and/or channel name.



### Timer info box

The timer info box is located above the tuner info box and is displayed in monitor mode. It displays the current status of the timer.

When a timer is programmed it shows a timer indication and the start time or date of the first programmed recording.

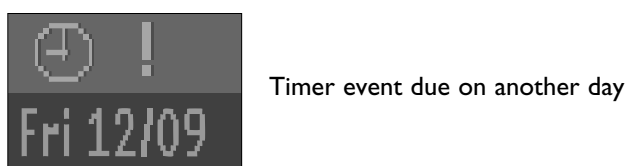

When an OTR recording is in progress it shows the end time.



When no timer is programmed it displays the current time.

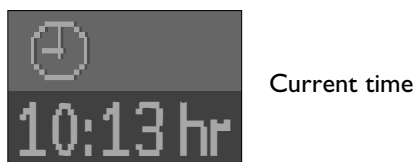

#### Note:

Tuner info box and timer info box disappear during playback and after recording is started.

### Warning box

The warning box will be displayed near the bottom of the screen when appropriate. For instance: 'Disc locked'.

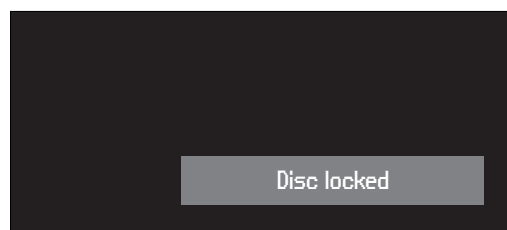

# Index Picture Screen

The Index Picture Screen displays an overview of the titles recorded on the disc. Each title is represented by an index picture. Next to the index picture the programme name, duration, recording mode and recording date of the title are shown. If no name is known, the DVD recorder will fill in the source and the time of the recording instead. Empty spaces (erased titles, or blank space at the end of the disc) are also shown as such.

- At maximum three titles will be shown on the screen at once. If more titles are present, you can navigate to those with the  $\nabla \triangle$  (down up cursor) keys.

- On the right hand side of the Index Picture Screen, you can see the disc bar. This gives an overview of all titles on the disc, as well as any empty spaces. On the disc bar, an arrow – the disc pointer – indicates your current position on the disc. From this point you may resume playback or recording.
- If you navigate through the list of titles with  $\nabla \triangle$  (down up cursor) or  $\blacktriangleleft$  **PREVIOUS** /  $\blacktriangleright$  **NEXT**, the disc pointer will move along.
- Press  $\blacksquare$  **STOP** to reset the disc pointer to the beginning of the disc.
- To move the disc pointer to the end of the last title, keep  $\blacktriangleright$  **NEXT** pressed.
- If you navigate from an Index Picture to the box right next to it (containing name, rec mode, etc.), you enter the title settings menu (see under 'Managing disc content - Title settings').

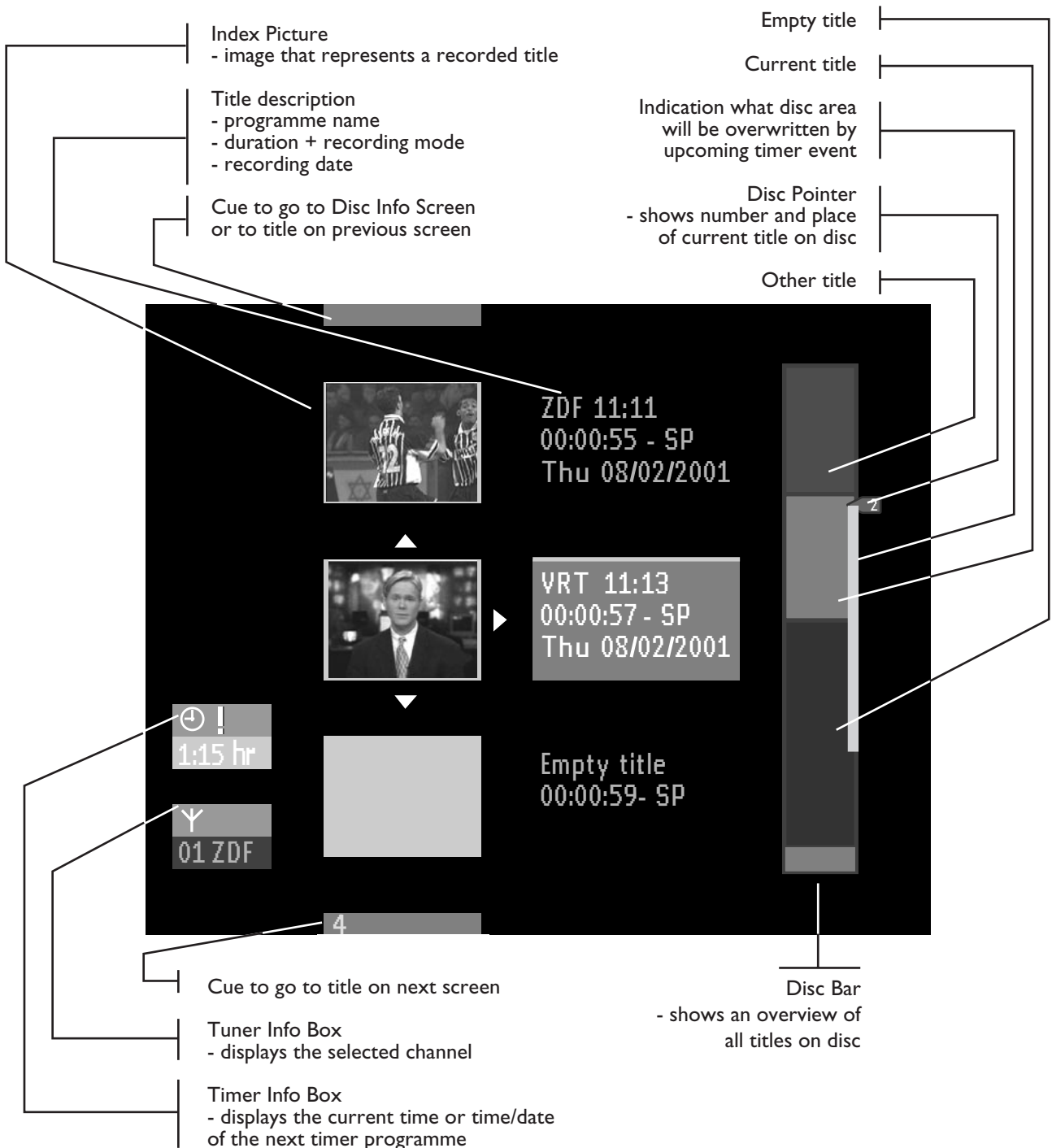

## ⚙️ User preferences

### Setting user preferences

You can set your user preferences for some of the recorder features. (See 'Operation' - 'User preferences menu operation')

The following items can be adapted:

### 👤 Picture settings

#### TV Shape

With TV Shape you can adjust the output of your DVD Recorder to optimally fit your TV screen. You can choose:

- **16:9** if you have a wide screen (16:9) TV set.
- **4:3** if you have a regular (4:3) TV set. In this case you can also choose between:
  - **Letterbox**: for a 'wide-screen' picture with black bars at the top and bottom,
  - **Pan Scan**: for a full-height picture with the sides trimmed. If a disc has Pan Scan, the picture then moves (pans) horizontally to keep the main action on the screen.

Optimal pictures on any TV screen	
Video format	Cinema format
Original material	
Material on disc	
Viewing on 16:9	
Viewing on 4:3	

#### Black level shift (NTSC only)

Adapts the colour dynamics to obtain richer contrasts. Select 'On' or 'Off'.

#### Video shift

Factory setting is such that the video will be centered on your screen. Use this setting to adjust the position of the picture on your TV set by scrolling it to the left or right.

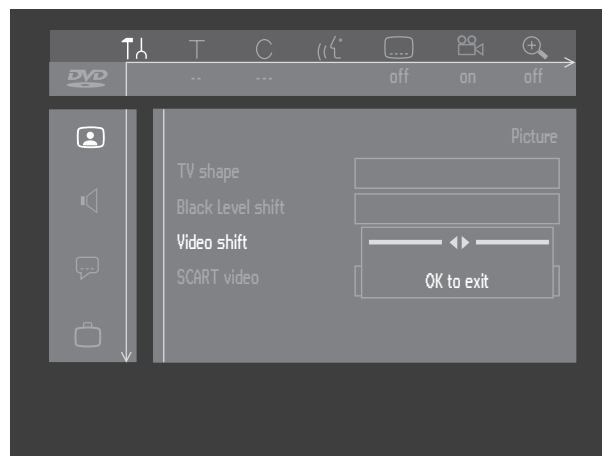

#### SCART Video

Factory setting is RGB. Select '**S-video**' (Y/C) via SCART when connecting to an S-VHS recorder.

### 🔊 Sound settings

#### Digital output

Factory setting 'All' means that both coaxial and optical outputs are switched on, and that Dolby Digital Multi-channel is fed to the outputs as such MPEG audio is converted to PCM. If your equipment doesn't include a digital Multi-channel decoder, set the digital output to '**PCM only**' (Pulse Code Modulation). Both coaxial and optical outputs are then switched on, and Dolby Digital and MPEG audio are converted to PCM. If you are not connecting equipment with a digital input, change the setting to '**Off**'.

#### Analogue output

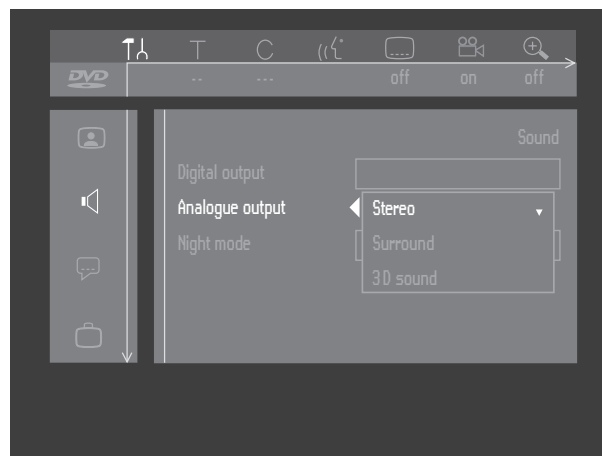

Select '**Stereo**', '**Surround**' or '**3D Sound**'. Factory setting is Stereo.

- Surround:** Select this setting when using equipment with a Dolby Surround Pro Logic decoder. In this setting the 5.1 audio channels (Dolby Digital, MPEG-2) are downmixed to a Surround-compatible 2-channel output.
- 3D Sound:** In a set-up without rear speakers (analogue stereo output), this option remixes the six channels of digital surround (Dolby Digital, MPEG-2) into a two speaker output, while retaining all of the original audio information. The result is the listening sensation of being surrounded by multiple speakers.

Connected audio system	Digital out	Analogue out
Amplifier or TV with two channel analogue stereo	Off	Stereo
Amplifier or TV with Dolby Surround or Dolby Pro Logic	Off	Surround
Amplifier with two channel digital stereo	PCM only	Stereo
A/V receiver with Multi-channel decoder (Dolby Digital, MPEG, DTS)	All	Stereo or Surround
Multi-channel A/V receiver with 6-ch connectors	Off	Surround

**Night Mode**

Night mode optimizes the dynamics of the sound with low volume playback for less disturbance in quiet environments. This only works for Dolby Digital audio on DVD-Video discs.

**Language settings**

The preferred language can be adapted via the system menu bar. Also see 'virgin mode'. Settings can be changed for:

- Playback audio language
- Subtitle language
- Menu language
- Country setting.

**Feature settings**

**Access Control**

Access Control contains the following features:

- Child Lock** - When Child Lock is set on, a 4-digit code needs to be entered in order to play discs.
- Parental Level** - Allows the conditional presentation of DVD discs containing Parental Level information.
- Change country** - Allows conditional presentation of DVD-Video discs containing country information.
- Change code** - To change the pin code. See 'Access Control'.

**Adapt disc format**

This option is only available when a DVD+RW or DVD+R disc recorded on a different brand of recorder is loaded. You can adapt the menu to your own recorder.

A DVD+RW video disc that has been recorded on a different type or brand of recorder can be played, but may not provide all features commonly available to DVD+RW discs, such as the on-screen disc bar, the disc settings menu, the title settings menu, and editing. If the disc is not write-protected, the disc format can be adapted to the own recorder, after which these functions are available.

**Status box**

The status box displays the current status of the recorder and the disc type loaded (See 'Operation' - 'On-screen display information'). You can switch it On or Off.

**Off** = always Off.

**On** = displayed together with the system menu bar or displayed temporarily (disappears after time-out) when changing the playback or record status.

Factory setting is 'On'.

**Auto resume**

The Auto resume setting only applies to pre-recorded DVD-video and Video CD discs only - not only to the disc in the recorder but also to the last twenty discs you have played.

If 'Auto resume' is set to 'On', playback will start from the point where it was stopped the last time the disc was played.

When 'Auto resume' is set to 'Off', the recorder will start playing from the beginning of a disc. In this case you can still resume when  appears on screen by pressing ► **PLAY**. Factory setting is 'On'.

**Low power standby**

If low power standby is 'On', the recorder will consume minimum power in standby mode.

Factory setting is 'Off'.

Notes:

When the recorder is in low power standby mode:

- the output of the equipment connected to EXT 2 will not be passed through to the TV set on EXT 1,
- the Display will be Off,
- the Standby indicator on the recorder will still light up in standby mode.

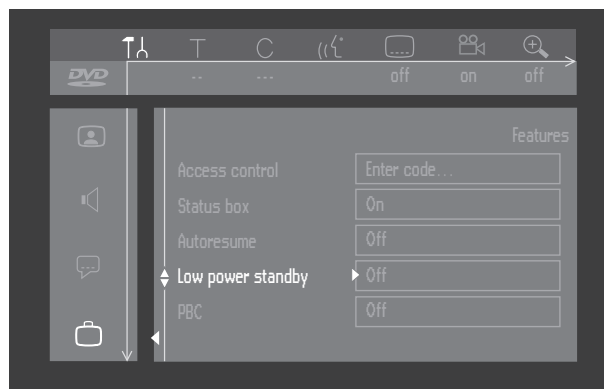



## PBC

This feature is only available when a (Super) Video CD is loaded. It allows you to disable or enable the PBC (Playback Control) menu of VCD discs. See under 'Special VCD features': Factory settings is 'On'.

## Finalise disc

This option is only available on unfinalised DVD+R discs. See 'Managing disc content - Finalising a DVD+R disc'.

## Remote Control settings

### Key sound

The recorder makes a 'beep' sound upon every key command given via recorder or remote control keys. Select 'Off' to disable this sound. Factory setting is 'On'.

### Remote control used

If you want to use the remote control of a Philips DVD player instead of the standard DVD recorder remote control, select 'DVD player'. Factory setting is 'DVD recorder'.

### System information

When you move further down in the Remote Control settings menu, the system status screen will appear. Press  $\Delta$  (cursor up) to go back.

## Record Settings

### Record mode

By selecting a recording mode you define picture quality of recordings and maximum recording time for a disc.

Mode	Picture quality	Total recording time
HQ (High Quality)	best possible picture quality	60 minutes
SP (Standard Play)	pre-recorded DVD quality	120 minutes
LP (Long Play)	better than S-VHS picture quality	180 minutes
EP (Extended Play)	better than VHS picture quality	240 minutes

In practice, the DVD recorder may record a few minutes more than indicated. For playback, the correct recording mode will automatically be selected. The HQ mode is optimised for recording via the i-link DV input. For all other sources use SP, LP or EP.

- In the record settings menu, select 'Record mode'.

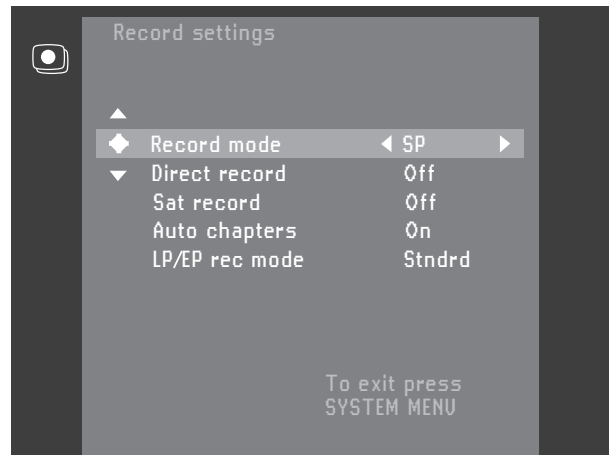

- Alter the recording mode with  $\triangleleft$  or  $\triangleright$  (left right cursor).
- Confirm with the **OK** key.
- To end, press **SYSTEM MENU**.

An alternative way to select the record mode is available in the Index Picture Screen and in monitor mode:

- Press **SELECT**.
  - The new record mode appears on the screen and the display.

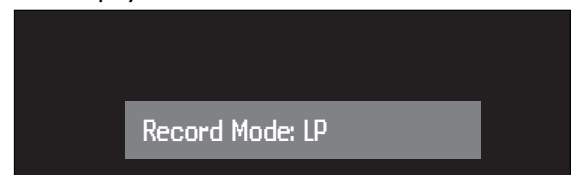

It is not possible to switch record modes during recording.

### Direct record

With the Direct Record function switched 'On' and the DVD recorder switched to standby, the channel number selected on your television will be automatically taken over by the DVD recorder, at the moment it starts recording. This only applies for televisions connected via scart, which have video output via SCART or which have EasyLink. Factory setting is 'Off'.

- In the record settings menu, select 'Direct record'.
- Select 'On'. If you select 'Off', the function will be switched off.
- Confirm with **OK**.
- To end, press **SYSTEM MENU**.

### Sat record

You can only use this function, when you have a satellite receiver, which can control other equipment by a 'programming' function. In this mode your DVD recorder starts recording when the satellite receiver releases a signal. The start and end of the recording is controlled via one of the SCART sockets.

- In the record settings menu, select 'Sat record'.
- Select the SCART socket to which the satellite receiver is connected with ◀ or ▶ (left right cursor).
- Confirm with **OK**.
- Insert a recordable DVD+RW disc.
- Press **STANDBY/ON**.
  - ▶ When this function is switched on, **SAT** appears on the display.
  - ▶ The DVD recorder is now prepared for recording.

Factory setting is 'Off'.

### Auto chapters

If autochapters is 'On' every five to six minutes a chapter marker (beginning of a new chapter) is inserted during recording. This enables easy navigation through a title during playback. In either case you can manually insert chapter markers afterwards. (See 'Managing disc content' - 'Edit in playback mode'.)

### LP/EP rec mode

In long play or extended play recording mode you can select the 'Sport' setting to optimize the video recording for images that contain fast movements, like sports programmes. The setting does not influence high quality or standard play recording mode.

Factory setting is 'Stndrd'.

## Installation

### Auto TV Channel Search

Your DVD recorder will search for all TV channels. It stores channels in the sequence they are found. (See 'Installation - First time Set-up')

Note:

All channels stored so far will be erased.

### Follow TV

With Follow TV you can programme the same channel sequence on the DVD recorder as on the TV set. This only functions if the recorder socket (EXT1) and the TV set are connected with a SCART cable. Additional equipment connected to socket EXT2 must be switched off.

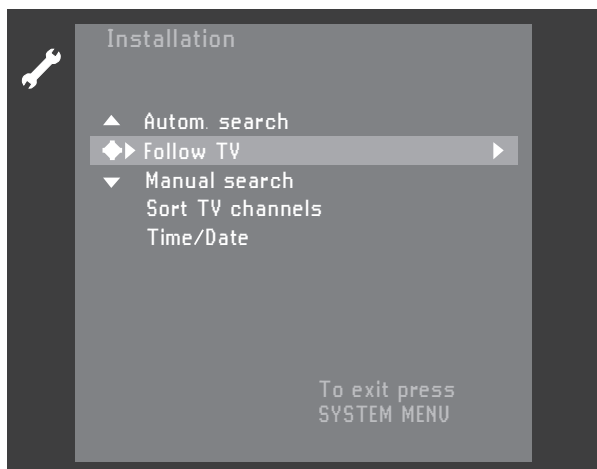

- Press **OK**.
  - ▶ If the DVD recorder recognizes that the TV set has been connected with a SCART cable, 'TV 01' appears on the display.



- ▶ When 'NOTV' (no signal from TV set) appears on the display, the TV channels can not be allocated automatically. In this case read 'Manual TV channel search'.
- Select programme number '1' on the TV set.
- Confirm with **OK** on the remote control of the DVD recorder.
  - ▶ The DVD recorder compares the TV channels on the TV set and the DVD recorder. If the channels match, this channel is stored at 'P01'.
- Wait until 'TV 02' appears and repeat the previous two steps for programme number 2 and the rest of the channels you want to store.
- To end, press **SYSTEM MENU**.

### Manual TV channel search

You can perform a search to select and store TV channels manually. If the DVD recorder is connected via EasyLink, this function is not available.

- Press **SYSTEM MENU**.
- Select 'Installation'.
- Select 'Manual search'.
- In the line 'Channel/freq.' select the display for:  
**Freq** : frequency  
**CH** : channel  
**S-CH** : special channel
- If you know the frequency or channel of the desired TV channel, you can enter the data in line 'Entry/search' with the digit keys **0-9**. If you don't know the frequency or channel of the TV channel of your choice, press  $\triangleright$  (right cursor) to start channel search.
- In the line 'Programme number' select the programme number you want, using  $\triangleleft$  or  $\triangleright$  (left right cursor) or digit keys **0-9**.
- If you want to change the TV channel name, press the  $\triangleright$  (right cursor) key in line 'TV channel name'.
- Select the character you want to change with the  $\triangleleft$  (left cursor) or  $\triangleright$  (right cursor) key.
- Change the character with the  $\nabla$  (down cursor) or  $\triangle$  (up cursor) key.
- Press **OK** to confirm.

This DVD recorder can receive HiFi sound transmissions in NICAM Stereo. However, if sound distortion occurs, due to poor reception, you can switch off NICAM:

- In the line 'NICAM' select 'On' or 'Off' with the  $\triangleleft$  (left cursor) or  $\triangleright$  (right cursor) key.

If you want to change the automatic TV channel setting, select the line 'Fine tuning'. With the  $\triangleleft$  (left cursor) or  $\triangleright$  (right cursor) key you can vary the automatic TV channel setting.

**Important:** This re-tuning is only necessary and useful in special cases, e.g. when stripes appear on your TV screen when using a cable-TV system.

- Press **OK** to store the TV channel.
- To end, press **SYSTEM MENU**.

### Connecting a decoder:

- Switch on the TV set and select the programme number for the DVD recorder.
- Select the TV programme you wish to link with the decoder function with **CH+** or **CH-**.
- Press **SYSTEM MENU**
- Select 'Installation'.
- Select 'Manual search'.
- Select 'Decoder'.
- Select 'On' with  $\triangleleft$  (left cursor) or  $\triangleright$  (right cursor).
- Confirm with **OK**.  
 $\triangleright$  'DECODER' appears on the display.
- To end, press **SYSTEM MENU**.

### Sort/Clear TV channels manually

- If the DVD recorder is connected to the TV set with EasyLink or a similar system, manual sort cannot be executed. In all other cases, you can select.
- Press **SYSTEM MENU**.
- Select the line 'Installation'.
- Select the line 'Sort TV channels'.

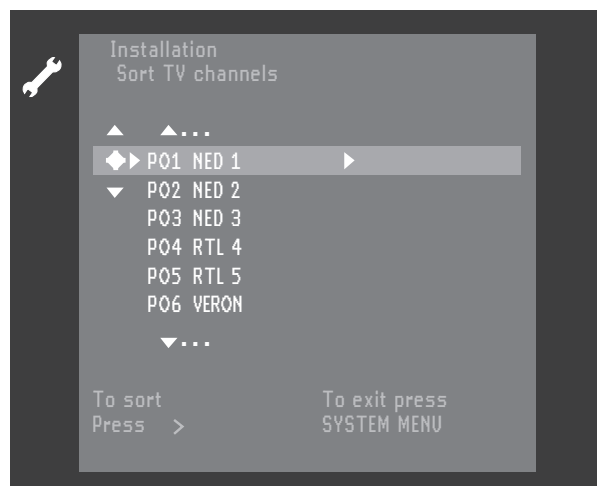

- Select the TV channel to which you want to allocate a programme number (starting with 'P01') with the  $\triangle$  (up cursor) or  $\nabla$  (down cursor) key and press the  $\triangleright$  (right cursor) key.
- Select the desired position with  $\triangle$  or  $\nabla$  (up down cursor) key.
- To store, press **OK**.
- To end, press **SYSTEM MENU**.

### Time/Date

To adjust 'Time', 'Year', 'Month' and 'Date' with the digit keys **0-9**. Switch between fields with the  $\nabla$   $\triangle$  (down up cursor) keys.

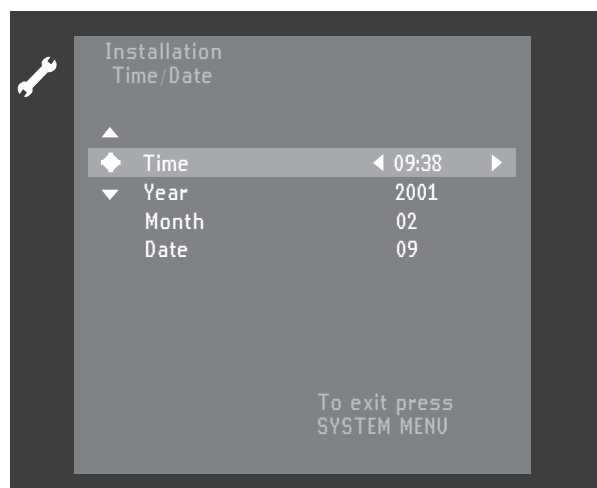

# Recording

## Before you start recording

Recordings on a DVD disc are called 'titles'. Every title consists of one or more chapters.

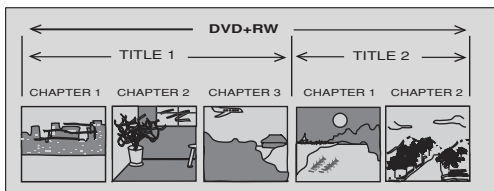

For more information about how to go to other titles or chapters see 'Playback - general features'.

### Important:

**Recordings on a DVD+RW disc are normally started from the position of the so-called disc pointer, i.e. the point where the last recording was stopped. From there on earlier recordings may be overwritten without notice, unless the disc is write protected. In this respect your DVD recorder behaves just like a Video Cassette Recorder.**

**If you want to make a recording without the risk of overwriting earlier recordings use the safe Record Function (see Manual Recording - Safe Record)**

In the Index Picture Screen you can select the point where you want to start your recording. Use the  $\nabla$   $\triangle$  (down up cursor) and **◀ REVERSE/▶ FORWARD** keys. You can see the current location on the disc bar, indicated by the arrow.

Your DVD recorder always checks the disc that you have inserted:

- ▶ When a DVD+RW disc is inserted on which recordings have been made, the Index Picture Screen is shown on your TV screen.
- ▶ If the inserted disc is a completely empty recordable disc, the message 'EMPTY DISC' appears on the display.
- ▶ If the inserted disc is a DVD+RW disc with a content that is not DVD-Video compatible (e.g. a data disc), a dialog box is shown with the option to erase or eject the disc. You can only record on this disc after erasing it with the **RECORD** key.

### Note:

- On a disc containing PAL recordings, no NTSC recordings can be made and vice versa. On an empty disc, either type of recordings can be made.
- No recordings can be made from so-called 'Pseudo-PAL' or PAL-60 sources.

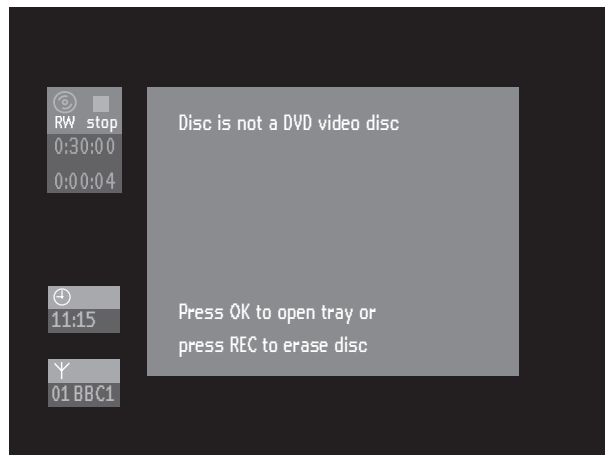

- ▶ A disc can hold up to 48 titles (including empty titles). When this maximum is reached the on-screen message 'Too many titles' appears, if you want to make a new recording. You have to erase a title first next to an empty title. (See 'Managing Disc Content'.)

## Manual recording

### Checking input

Normally, the DVD recorder displays the contents of the disc on screen.

- Press **MONITOR** in order to switch to the internal tuner, or whichever other source is selected, if you want to check the input before starting a recording.
  - ▶ On the TV screen, you will see the actual picture quality that you will get if you record: the video has been encoded and decoded again. This is why you will see a delay of about 1.5 seconds when using a 'live' source such as a camera.
- In monitor mode you can choose programme numbers directly with the digit keys **0-9** on the remote control.
- Press **SELECT** repeatedly to select the desired record mode.
- Press **MONITOR** again to go back to disc mode.

### Recording

- Insert a recordable DVD+RW or DVD+R disc.
- Normally, the DVD recorder displays the contents of the disc on the screen.
- Use the **MONITOR** button to see the currently selected TV channel.
- Use **CHANNEL ▲** or **CHANNEL ▼** (on the recorder) or **CH+**, **CH-** (on the remote control) to select the programme number (programme name) from which you wish to record.
  - ▶ When a TV channel transmits a channel name, it will be shown on the display.

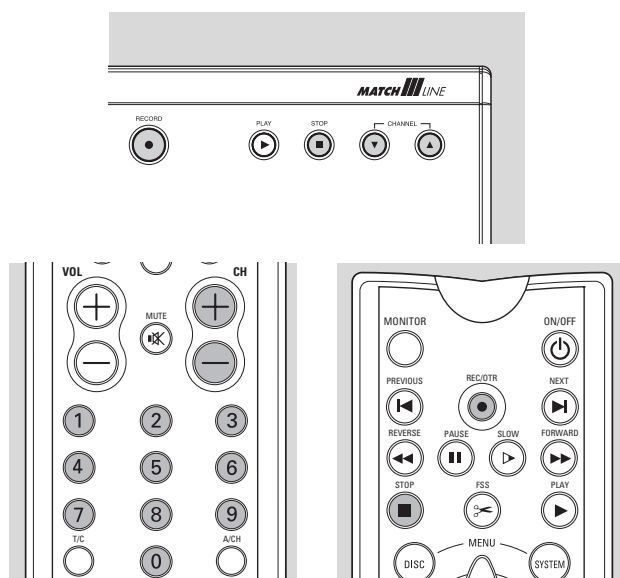

The following programme numbers are provided for recording from external sources:

'EXT1' : TV set via SCART 1 socket

'EXT2' : for recording from external sources via SCART 2 socket

'EXT3' : rear S-video

'EXT4' : rear CVBS

'CAM1' : front S-video (Y/C)

'CAM2' : front Video (CVBS)

'CAM3' : front DV.

- Press **RECORD** (on the recorder) or **REC/OTR** (on the remote control).
  - **RECORD** is shown on the display.
  - The status box is shown on the screen for a few seconds.

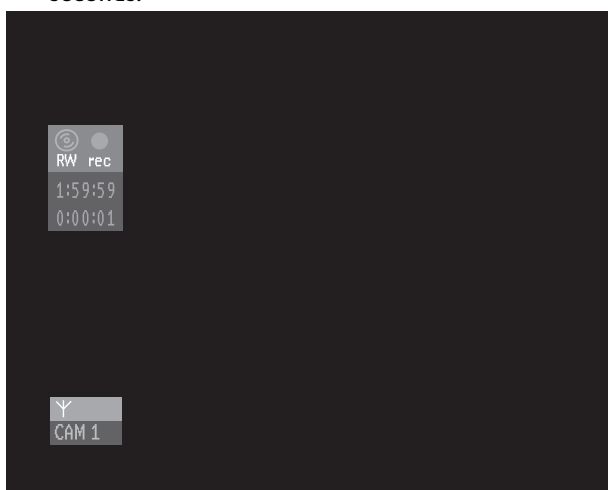

- To bring back the status box during recording press **SYSTEM MENU**. Pressing **SYSTEM MENU** once more will remove the status box again.
- Press **II PAUSE** to pause recording. You can resume recording by pressing **II PAUSE** once more. The DVD recorder will make a seamless connection.
- Press **■ STOP** to stop recording. If you are recording from a camcorder watch the video output of the DVD recorder on the TV - instead of the camcorder viewer - to determine the right moment to stop.

- The Index Picture Screen is updated.
  - 'MENU UPDATE' is shown on the display.
- After a short recording on a new DVD+RW disc, a few minutes will be needed to complete the formatting of the disc.

### Safe Recording

When you start recording on a DVD+RW disc by briefly pressing the **RECORD** or **REC/OTR** key, a recording on DVD+RW will be made from the current position of the disc pointer. To prevent this do the following:

- Hold the **RECORD** key (on the recorder) or **REC/OTR** key (on the remote control) press for about two seconds until 'SAFE RECORD' appears on the display.
- The recorder automatically jumps to the end of the last title on the disc and starts recording.
  - If no free space is left. The display will show 'DISC FULL'. Safe record is not possible then.

Recordings on DVD+RW are always automatically made after the last title on the disc.

### Direct Record

With Direct Record you can start recording immediately from the programme selected on the TV set.

- Make sure 'Direct record' is switched 'On'. (See record settings).
- On the TV set, select the programme number you want make the recording from.
- Make sure the DVD recorder is switched to standby.
- Press **RECORD** (on the recorder) or **REC/OTR** (on the remote control).

### Notes :

- Don't select another programme number on your TV set, until the 'WAIT' on the display of your DVD recorder disappears. This can take up to one minute.
- When 'NOTV' appears on the display, the programme number could not be found. The DVD recorder switches off automatically.
- If your loudspeakers are connected (via an amplifier / receiver) to your DVD recorder, the sound will be delayed relative to the TV picture when recording directly from the TV set.
- You can use Direct Record in combination with Safe Record.

### Manual audio control

You can control the audio recording level of your DVD recorder manually.

- In monitor mode, press **AUTO/MAN REC VOLUME** on the DVD recorder.
  - The display will show the current audio level and **MANUAL** appears.

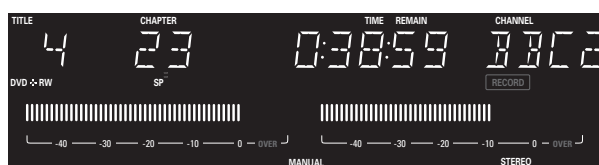

- Adjust the recording level with **MANUAL ▲** or **▼** on the DVD recorder, so that the '0 dB' mark lights up during the loudest parts of the recording.
- You can switch back to automatic audio level control by pressing **AUTO/MAN REC VOLUME** again.
  - ▶ The display will show the current disc position and **MANUAL** disappears.

Note :

When DV input is selected, manual volume control is disabled.

## Recording with automatic switch-off (OTR One-Touch Recording)

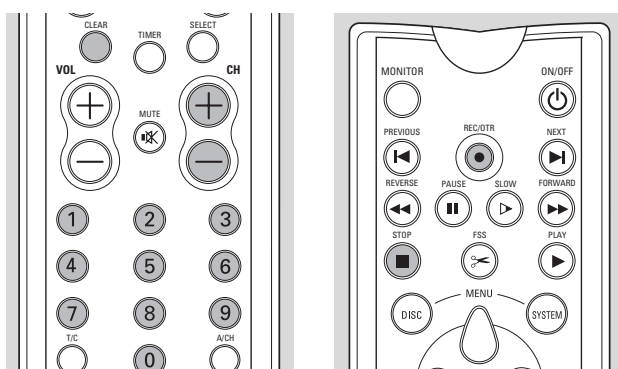

- Insert a recordable DVD+RW or DVD+R disc.
- Use **CHANNEL ▲** or **CHANNEL ▼** (on the recorder) or **CH+**, **CH-** (on the remote control) to select the programme number (programme name) from which you wish to record.
- Press **RECORD** (on the recorder) or **REC/OTR** (on the remote control) twice.
  - ▶ A recording will be made of 30 minutes.
  - ▶ The required end time of the recording is shown in the timer box on screen. The remaining recording time is shown on the display.



- Press **RECORD** or **REC/OTR** again to obtain a 30 minute increment.
- Shortly after pressing **REC/OTR**, OTR can be cancelled by pressing **CLEAR**.

## Timer programming

The DVD recorder needs the following information for every programmed recording:

- the date on which the recording is to be made;
- the channel;
- the start and stop time of the recording;
- VPS/PDC on or off;
- the recording mode (HQ, SP, LP or EP).

The DVD recorder stores all the information mentioned above in a timer block. You can programme up to six timer blocks, one month in advance.

When you have programmed the timer, a red line on the disc bar (both on the display and on the Index Picture Screen) indicates what part of the disc will be overwritten by the programmed recording from the current disc position (on DVD+RW) or after the last title (on DVD+R).

When all timer blocks are full, the options timer programming and VIDEO Plus+ programming cannot be accessed. For clearing a timer block, see 'How to clear a timer block'.

### What is 'VPS'/'PDC'?

With 'VPS/PDC', the TV station controls the beginning and the length of the programmed recording. This means that the video recorder switches itself on and off at the right time even if a TV programme you have programmed begins earlier or finishes later than expected. Usually the start time is the same as the VPS/PDC time. If, however, in the TV guide, in addition to a TV programmes start time, a different VPS/PDC time is given, e.g.: '20.15 (VPS 20.14)', you must enter '20.14' as the start time exactly to the minute. If you want to enter a time that differs from the VPS/PDC time, you must switch off 'VPS/PDC'.

## Timer programming with the VIDEO Plus+® system

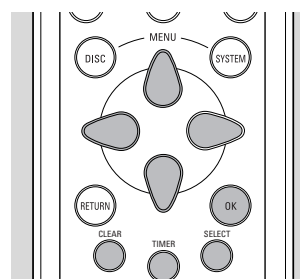

A PlusCode number is a number of up to nine digits, printed in most TV guides next to the start time of a TV programme.

All the information required for a programming is contained encoded in the PlusCode programming number.

- Select '**VIDEO Plus+ programming**' with **▲** (up cursor) or **▼** (down cursor).

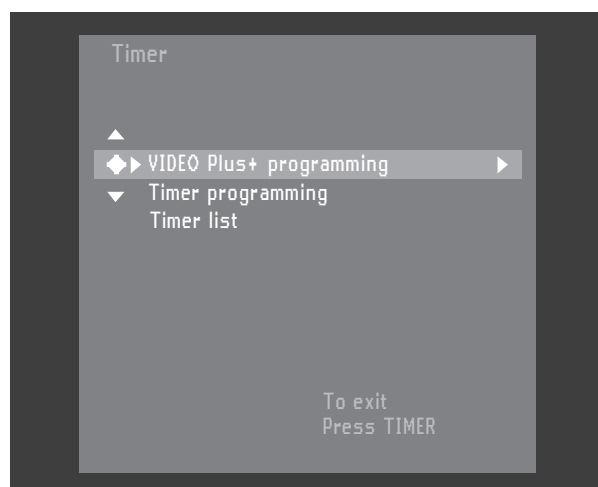

- Press **▶** (right cursor).



- Enter the entire PlusCode number (up to nine digits) printed in your TV guide next to the start time of a TV programme. If you made a mistake, you can correct it with **CLEAR**.
- Confirm with **OK**.
- If the VIDEO Plus+ system does not recognize the TV channel, the message 'Please enter programme number' will appear on screen. Select the required programme number (programme name) with ◀▶ (left right cursor) or the digit keys **0-9** and confirm with **OK**.

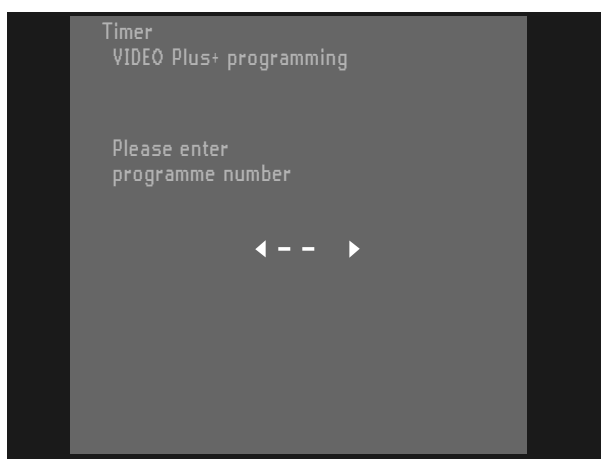

- ▶ The data will appear on the TV screen.
- Press ▶ (right cursor).
- Use **SELECT** to select the programming key at daily or weekly intervals. **Mo-Fr**: Recording at daily intervals from Mondays to Fridays inclusive. **Weekly**: Recording at weekly intervals on the same day of the week.
- Press ▶ (right cursor).
- Use **SELECT** to switch VPS/PDC on or off.
  - ▶ When VPS/PDC is switched on, the start time is marked with an asterisk.
- Press ▶ (right cursor).
- Use **SELECT** to select the recording mode ('HQ', 'SP', 'LP', 'EP').



- Confirm with **OK**.
  - ▶ The data has been stored in a timer block.
- To end, press **TIMER**.
- Make sure that you inserted a recordable disc. If you inserted a write-protected disc recording will be refused.
- Switch off with ⏻ **STANDBY/ON**.

### Timer programming without the VIDEO Plus+ system

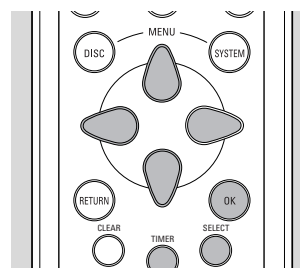

- Press **TIMER** on the remote control.
- Select '**Timer programming**' with ▲ (up cursor) or ▼ (down cursor).

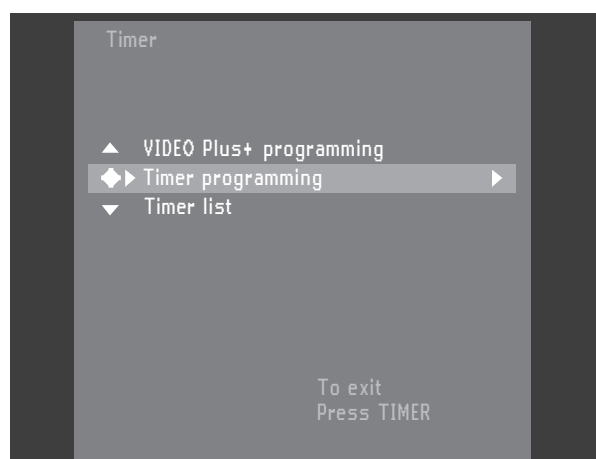

- Press ▶ (right cursor).
- Enter the date with ▲ (up cursor) or ▼ (down cursor), or with the digit keys **0-9**.



- If desired, select recording at daily or weekly intervals in the field 'Date' with **SELECT**. 'Mo-Fr': Recording to be made from Mondays to Fridays inclusive. 'Weekly': Recording at weekly intervals on the same day of the week.
- Press  $\triangleright$  (right cursor).
- Enter the programme number from which you want to record. If you want to record from an external source, select 'EXT1', 'EXT2', 'EXT3', 'EXT4', 'CAM1', 'CAM2' or 'CAM3' with  $\triangle\triangledown$  (up down cursor).
- Press  $\triangleright$  (right cursor).
- Enter the Start time with  $\triangle\triangledown$  (up down cursor) or the digit keys **0-9**.
- After entering the Start time, use **SELECT** to switch VPS/PDC on or off. With most TV stations the VPS/PDC time is always the same as the start time.
  - When VPS/PDC is switched on, the start time is marked with an asterisk.
- Press  $\triangleright$  (right cursor).
- Enter the End time with  $\triangle\triangledown$  (up down cursor) or the digit keys **0-9**.
- Use **SELECT** to choose the recording mode 'HQ', 'LP', 'SP' or 'EP'.
- If you made a mistake, you can go back with  $\triangleleft$  (left cursor).



- Confirm with **OK**.
  - The data has been stored in a timer block.
- To end, press **TIMER**.
  - Make sure that you inserted a disc without write protection. If you inserted a write-protected (locked) disc, recording will be refused.
- Switch off with  $\text{⏻}$  **STANDBY/ON**.

## Programming with 'NEXTVIEW Link'

This DVD recorder is equipped with the function 'NEXTVIEW Link'. If your television is also equipped with this function, you can mark TV programmes on the television for programming. These TV programmes will automatically be transmitted to a timer block on the DVD recorder. If you clear the marking of the TV programme on the television, the corresponding timer block on the DVD recorder will also be cleared. For more information, read the instruction manual of your TV set.

## If a timer setting is incorrect

The following warnings can be displayed in the timer menu:

### Collision

recording programme overlaps with another recording programme.

#### Solution:

- Ignore by pressing **TIMER**. The programme with the earlier start time will be recorded completely before the later programme starts.
- Edit one or both timers.
- Delete one of the recording programmes.

### Please enter programme number

The VIDEO Plus+ system does not recognize the TV channel.

#### Solution:

- Select the required programme number (programme name) with  $\triangleleft$  or  $\triangleright$  (left right cursor).
- Confirm with **OK**.

### PlusCode number wrong

You entered an incorrect PlusCode number or the incorrect date.

#### Solution:

- Repeat the entry or end by pressing **TIMER**.

### Weekend programming - not possible

Date was incorrectly entered. Daily programming can only be used for recordings to be made from Mondays to Fridays inclusive.

### Memory full

The maximum number of recording programmes is used.

#### Solution:

- Delete one of the recording programmes.



## How to check or alter a timer block

- Press **TIMER** on the remote control.
- Select 'Timer list' with  $\nabla$  or  $\triangle$  (down up cursor).

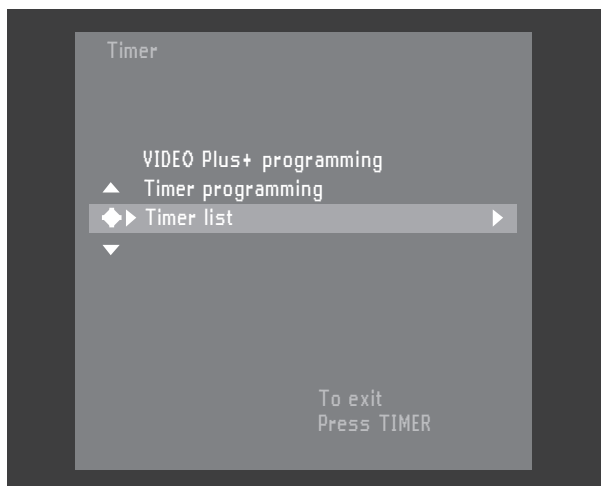

- Press  $\triangleright$  (right cursor).

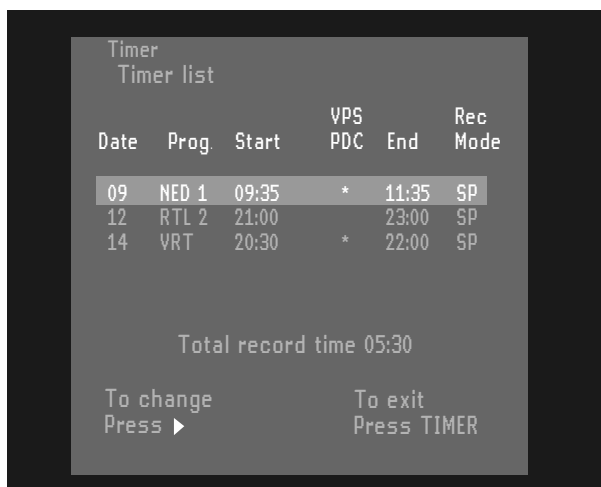

- Select the timer block you want to check or alter with  $\nabla$  or  $\triangle$  (down up cursor).
- Press  $\triangleright$  (right cursor).
- Select what you want to check or alter with  $\triangleleft$  or  $\triangleright$  (left right cursor).
- Alter data with  $\nabla$  or  $\triangle$  (down up cursor) or with the digit keys **0-9**.
- Confirm with **OK**.
- To end, press **TIMER**.
- Switch off by pressing  $\text{⏻}$  **STANDBY/ON**.

## How to clear a timer block

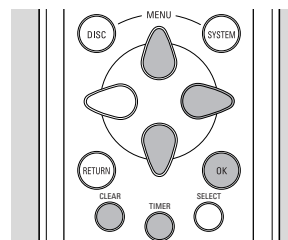

- Press **TIMER** on the remote control.
- Select 'Timer list' with  $\nabla$  or  $\triangle$  (down up cursor).
- Press  $\triangleright$  (right cursor).
- Select the timer block you want to clear with  $\nabla$  or  $\triangle$  (down up cursor).
- Press **CLEAR**.
- Confirm with **OK**.
- Switch off by pressing **TIMER**.

# Playback

## Playing a DVD+RW or DVD+R disc



- Insert a DVD+RW or DVD+R disc.
  - If the inserted disc is write-protected, playback starts automatically otherwise the Index Picture Screen appears.
- Press **▶ PLAY**.
  - Playback starts automatically from the point where it was stopped the last time the disc was played or recorded. If you want to start playback from the beginning of the disc, you can do so via the Index Picture Screen (see 'Index Picture Screen').
  - If the disc is a new blank disc, the display will show 'EMPTY DISC'.
- To stop playback at any time, press **■ STOP**.
  - You return to the Index Picture Screen.

## Playing a pre-recorded DVD-Video disc



Some DVD discs are produced in a way that requires specific operation or allows only limited operation during playback. In these cases the recorder may not respond to all operating commands. When this occurs, please refer to the instructions in the disc inlay. When a  appears on the TV screen, the operation is not permitted by the recorder or the disc.

- Insert a pre-recorded DVD-Video disc. Make sure the label is facing up. If the disc is two-sided, make sure the label of the side you want to play is facing up.
  - When 'autoresume' is set to 'On' (see 'User Preferences') playback starts automatically from the point where it was stopped, the last time the disc was played.
  - When 'autoresume' is set to 'Off', the disc will play from the start of the disc. You can however resume play from the point at which you stopped, the last time the disc was played, by pressing **▶ PLAY** when  appears on screen.
  - The currently playing title and chapter number are displayed on the recorder display. The elapsed time is shown also.

Notes:

- DVD movies to be released at different times in different regions of the world, all players have region codes and discs can have an optional region code. If you load a disc of a different region code to your recorder, you will see the region code notice on the screen. The disc will not play, and should be unloaded.



- The region code is stated on a label on the back side of your recorder.
- Regional coding is not applicable for recordable DVD discs.

- The disc may invite you to select an item from a menu. If the selections are numbered, press the appropriate numerical key; if not, use the  $\nabla \triangle \triangleright \triangleleft$  (down up right left cursor) keys to highlight your selection, and press **OK**.
- To stop play at any time, press **■ STOP**.
  - The default screen will appear, giving information about the current status of the recorder.

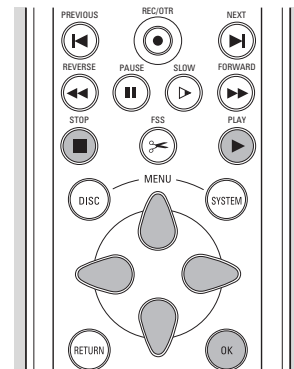

Note:

During playback you can display and enter the menu by pressing **DISC MENU**.

## Playing a (Super) Video CD disc



- Insert a (Super) Video CD.
  - When 'autoresume' is set to 'On' (see 'User Preferences') playback starts automatically from the point where it was stopped, the last time the disc was played.
  - The disc may invite you to select an item from a menu. If the selections are numbered, press the appropriate numerical key **0-9**.
- To stop play at any time, press **■ STOP**.
  - The default screen will appear.

## General features



Note:

Unless stated otherwise, all operations described are based on remote control operation. A number of operations can also be carried out via the system menu bar on the screen. (see 'System menu bar operation')

## Moving to another title/track

When a disc has more than one title or track, you can move to another title as follows:

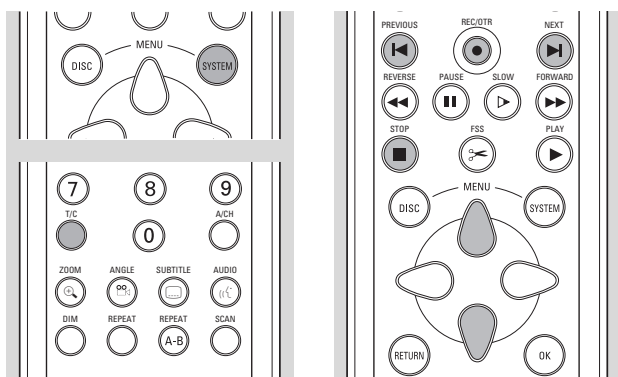

- Press **T/C**.
- Press **▶ NEXT** during play to step forward to the next title.
- Press **◀ PREVIOUS** during play to return to the beginning of the current title. Rapidly press **◀ PREVIOUS** twice to step back to the previous title.
- To go directly to any title or track, enter the title number using the numerical keys **0-9**.

Notes:

- If the number has more than one digit, press the keys in rapid succession.
- If the system menu bar is on screen, make sure the **T** icon is selected.

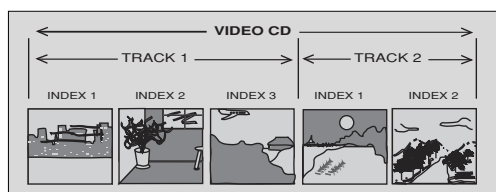
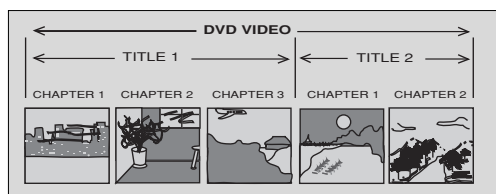

## Moving to another chapter/index

When a title on a disc has more than one chapter or a track has more than one index, you can move to another chapter/index as follows:

- Press **▶ NEXT** during play to select the next chapter/index.
- Press **◀ PREVIOUS** during play to return to the beginning of the current chapter/index. Rapidly press **◀ PREVIOUS** twice to step back to the previous chapter/index.
- To go directly to any chapter or index, enter the chapter or index number using the numerical keys **0-9**.

Notes:

- If the number has more than one digit, press the keys in rapid succession.
- If the system menu bar is on screen, make sure the **C** icon is selected.

## Slow Motion

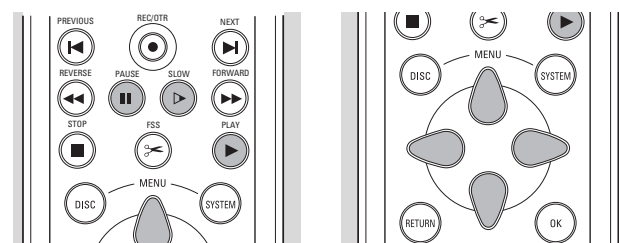

- Select **▷ (Slow motion)** in the system menu bar.
- Use the **▽ (down cursor)** key to enter the slow motion menu.
  - ▶ The recorder will now go into pause mode.



- Use the **◀ ▶ (left right cursor)** keys to select the required speed: '**1**', '**1/2**', '**1/4**' or '**1/8**' (backward); '**1/8**', '**1/4**', '**1/2**' or '**1**' (forward).
- Select '**1**' to play at normal speed again.
- If **|| PAUSE** is pressed, the speed will be set to '**0**'.
- Press **▶ PLAY** to exit slow motion mode.
- Press **△ (up cursor)** to delete the slow motion menu. You can also select Slow Motion speeds by using the **▷ SLOW** key on the remote control.

## Still Picture and Step Frame

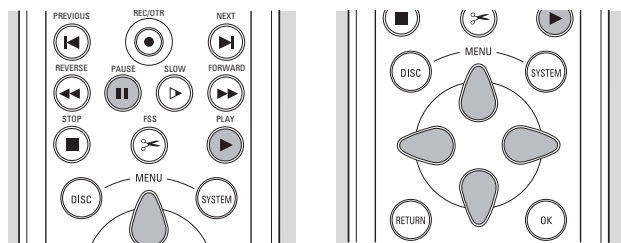

- Select (picture by picture) in the system menu bar.
- Use the (down cursor) key to enter the picture by picture menu.
  - The recorder will now go into pause mode.



- Use (left right cursor) keys to select previous or next picture.
- Press **PLAY** to exit picture by picture mode.
- Press (up cursor) to exit the picture by picture menu.

You can also step forward by using the **PAUSE** repeatedly on the remote control.

## Search

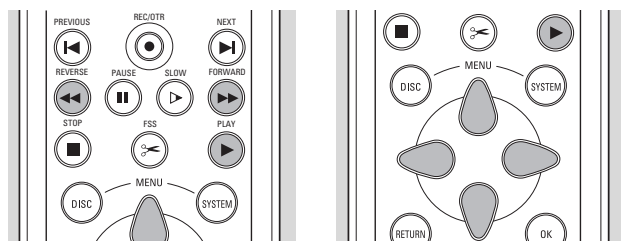

- Select (Fast motion) in the system menu bar.
- Use the (down cursor) keys to enter the fast motion menu.



- Use the (left right cursor) keys to select the required speed: '-32', '-8' or '-4' (backward); '4', '8', '32' (forward).
  - Select '1' to play at normal speed again.
  - Press **PLAY** to exit fast motion mode.
  - Press (up cursor) to delete the fast motion menu.
- To search forward or backward through different speeds, you can also press **REVERSE** or **FORWARD** again.

## Repeat

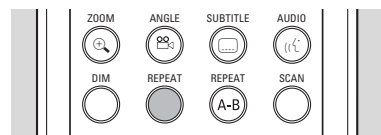

### DVD Discs - Repeat chapter/title/disc

- To repeat the currently playing chapter, press **REPEAT**.
  - appears on screen.
- To repeat the currently playing title, press **REPEAT** a second time
  - appears on screen.
- To repeat the entire disc, press **REPEAT** a third time
  - appears on screen.
- To exit repeat mode, press **REPEAT** a fourth time.

### Video CDs - Repeat track/disc

- To repeat the currently playing track, press **REPEAT**.
  - appears on screen.
- To repeat the entire disc, press **REPEAT** a second time.
  - appears on screen.
- To exit repeat mode, press **REPEAT** a third time.

## Repeat A-B

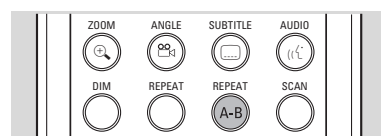

To repeat or loop a sequence in a title:

- Press **REPEAT A-B** at your chosen starting point;
  - appears on screen.
- Press **REPEAT A-B** again at your chosen end point;
  - repeat appears on screen, and the repeat sequence begins.
- To exit the sequence, press **REPEAT A-B**.

## Scan

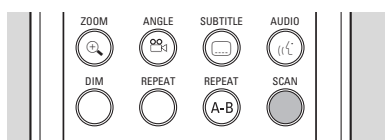

Plays the first 10 seconds of each chapter/index on the disc.

- Press **SCAN**.
- To continue play at your chosen chapter/index, press **SCAN** again or press ► **PLAY**.

## Time search

The Time Search function allows you to start playing at any chosen time stamp.

- Select (Time Search) in the system menu bar.
- Press (down cursor).
  - The recorder will now go into pause mode.
  - A time entry box appears on the screen showing the elapsed playing time of the current disc.



- Use the digit keys **0-9** to enter the required start time. Enter hours, minutes and seconds in the box.
  - Each time an item has been entered, the next item will be highlighted.
- Press **OK** to confirm the start time.
  - The time entry box will disappear and play starts from the selected time position.

## Zoom

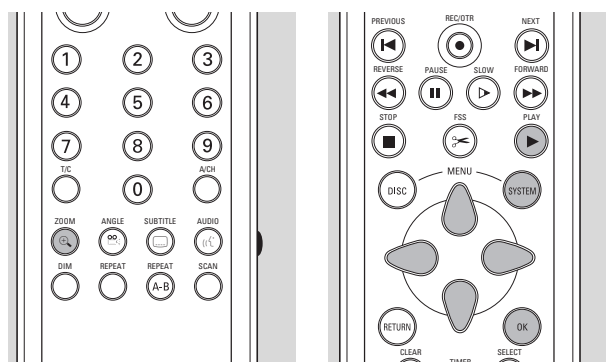

The Zoom function allows you to enlarge the video image and to pan through the enlarged image.

- Select Zoom in the system menu bar.
- Press (down up cursor) to activate the Zoom function and select the required zoom factor; 1.33 or 2 or 4.
  - The recorder will go into pause mode.
  - The selected zoom factor appears below the Zoom icon in the system menu bar and 'Press OK to pan' appears below the system menu bar.

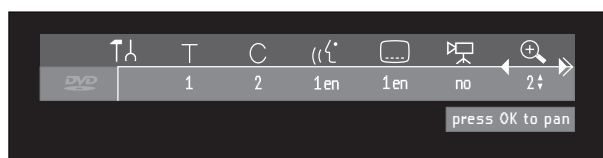

- The picture will change accordingly.
- Press **OK** to confirm the selection.
  - The panning icons appear on the screen: (down up right left cursor) and **OK**.
- Use the (down up right left cursor) keys to pan all over the screen.
- When **OK** is pressed only the zoomed picture will be shown on the screen.
- If you wish to zoom at any moment, press Zoom and select the required zoom factor as described above.
- Press ► **PLAY** to exit zoom mode.

## Special DVD+R(W) features

### Recording date and time

If a recording was made from a digital camcorder using the i.LINK DV input, the original recording date and time are automatically stored as DVD subtitles.

- Press **⏏** **SUBTITLE** to display the recording date and time.
  - ▶ The recording date and time are displayed in the right bottom corner of the screen.



## Special DVD-Video features

### Menus on the disc

For titles and chapters, selection menus may be included on the disc.

The DVD's menu feature allows you to make selections from these menus. Press the appropriate numerical key; or use the  $\nabla \triangle \triangleright \triangleleft$  (down up right left cursor) keys to highlight your selection, and press **OK**.

#### Title menus

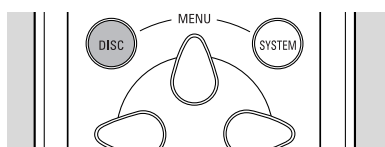

- Press **DISC MENU**.
  - ▶ If the current title has a menu, this appears on the screen. If no menu is present in the title, the disc menu will be displayed.
- The menu can list camera angles, spoken language and subtitle options, and chapters for the title.
- To exit the title menu, press **DISC MENU** again.

*Note:*

*Most DVD discs do not have separate disc and title menus.*

#### Disc menu

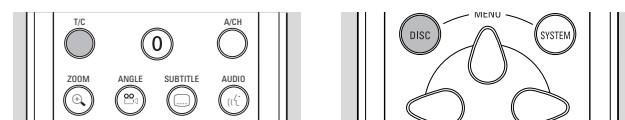

If a DVD-Video disc has separate disc and title menus, you can navigate to the disc menu as follows:

- Press **T/C** followed by **DISC MENU**.
  - ▶ The disc menu is displayed.
- To remove the disc menu, press **DISC MENU** again.

## Camera Angle

If the disc contains sequences recorded from different camera angles, the angle box appears, showing the number of available angles, and the angle being shown. You can then change the camera angle if you wish.

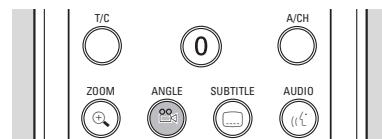

- Use the  $\nabla \triangle$  keys to select the required angle in the angle box.
- To go to any angle directly, enter the angle number using the numerical keys **0-9**.
  - ▶ After a small delay, play changes to the selected angle. The angle box remains displayed until multiple angles are no longer available.

## Changing the audio language

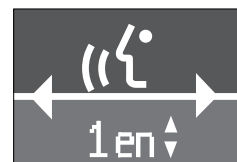



- Select **⏏** (Audio) in the system menu bar.
- Press **⏏** **AUDIO** or  $\nabla \triangle$  (down up cursor) repeatedly to step through the different languages.
- You can enter the required language number directly using the numerical keys **0-9**.

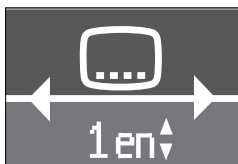

## Subtitles



- Select  (Subtitle) in the system menu bar.
- Press  **SUBTITLE** or  $\nabla$   $\triangle$  (down up cursor) repeatedly to step through the different subtitles, or to switch the subtitles off.
- You can enter the required subtitle number directly using the numerical keys **0-9**.

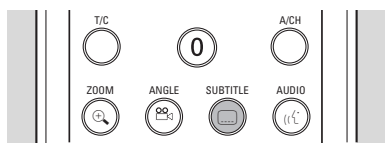

## Special VCD features

### Playback Control (PBC)

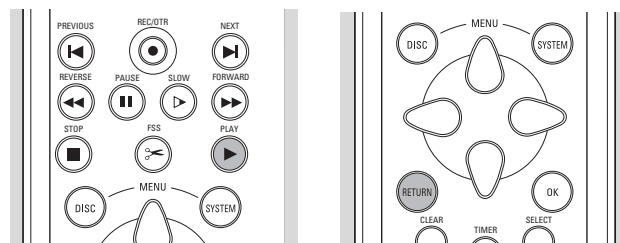

- Make sure PBC is switched 'On'. See 'User Preferences-features settings'.
- Load a (Super) Video CD with PBC and press **▶ PLAY**.
  - ▶ The PBC menu appears on screen.
- Go through the menu with the keys indicated on the TV screen until your chosen passage starts to play. If a PBC menu consists of a list of titles, you can select a title directly.
- Enter your choice with the numerical keys **0-9**.
- Press **RETURN** to go back to the previous menu.

### Playing an audio CD

- Insert the disc.
  - ▶ After loading the disc, playback starts automatically.
  - ▶ If the TV set is on, the Audio CD screen appears.
  - ▶ During play, the current track number and its elapsed playing time will be shown on the screen and the recorder display.

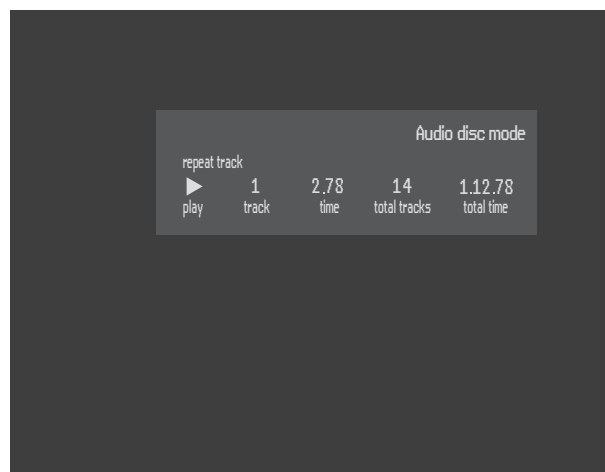

- To stop play at any time, press **■ STOP**.
  - ▶ The number of tracks and the total playing time will be shown on the screen and the recorder display.

## Pause

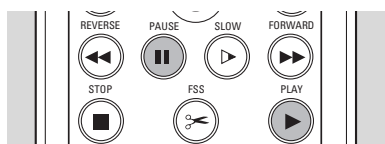

- Press **II PAUSE** during play.
- To return to play, press **▶ PLAY**.

## Search

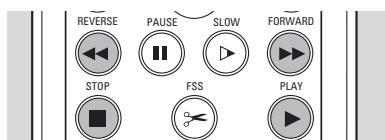

- To search forwards or backwards through the disc at 4x normal speed, press **◀ REVERSE** or **▶ FORWARD**.  
▶ Search begins.
- To step up to 8x normal speed, press **◀ REVERSE** or **▶ FORWARD** again.  
▶ Search goes to 8x speed, and the sound is muted.
- To return to 4x normal speed, press **◀ REVERSE** or **▶ FORWARD** again.
- If the TV set is on, search speed and direction are indicated on the screen each time **◀ REVERSE** or **▶ FORWARD** is pressed.
- To end the search, press **▶ PLAY** or **■ STOP** as desired.

## Moving to another track

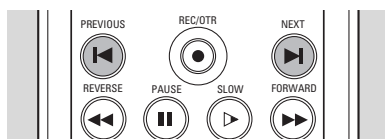

- Press **▶ NEXT** during play to step forward to the next track.
- Press **◀ PREVIOUS** during play to return to the beginning of the current track. Rapidly press **◀ PREVIOUS** twice to step back to the previous track.
- To go directly to any track, enter the track number using the numerical keys **0-9**.

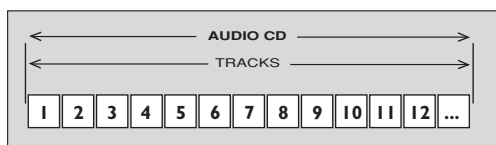

## Repeat track/disc

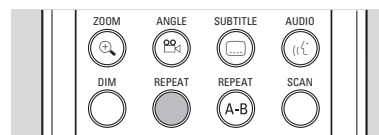

- To repeat the currently playing track, press **REPEAT**.  
▶ 'Repeat track' appears on screen.
- To repeat the entire disc, press **REPEAT** a second time.  
▶ 'Repeat disc' appears on screen.
- To exit repeat mode, press **REPEAT** a third time.

## Repeat A-B

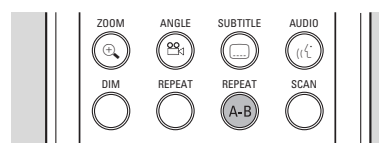

To repeat or loop a sequence:

- Press **REPEAT A-B** at your chosen starting point;  
▶ 'Repeat A' appears on screen.
- Press **REPEAT A-B** again at your chosen end point;  
▶ 'Repeat A-B' appears on the display, and the repeat sequence begins.
- To exit the sequence, press **REPEAT A-B** again.

## Scan

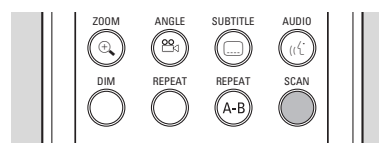

Plays the first 10 seconds of each track on the disc.

- Press **SCAN**.
- To continue play at your chosen track, press **SCAN** again or press **▶ PLAY**.



# Access control

## Child Lock (DVD and VCD)

When activating Child lock, only discs that are authorised can be played without PIN code.

The recorder memory maintains a list of 50 authorized ('Child safe') disc titles. A disc will be placed in the list when 'Play Always' is selected in the 'Child protect' dialog. Each time a 'Child safe' disc is played it will be placed on top of the list. When the list is full and a new disc is added, the least recently used will be removed from the list.

### Activating/deactivating the child lock

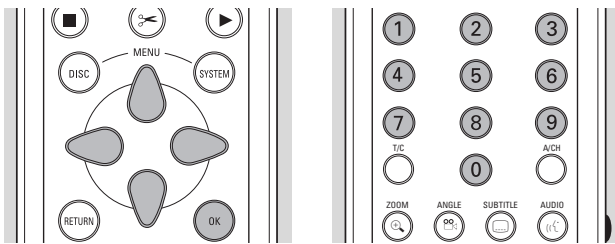

- Select 'Access control' in the features menu using  $\nabla/\Delta$  (down up cursor) and press  $\triangleright$  (right cursor).

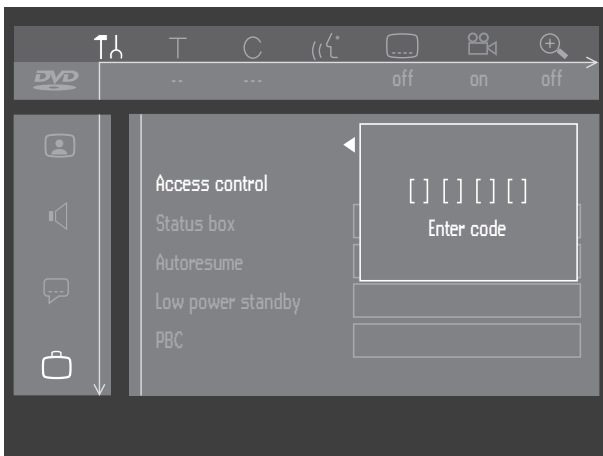

- Enter a 4-digit PIN code of your own choice using the digit keys **0-9**.
- Enter the code a second time.
- Move to 'Child lock' using  $\nabla/\Delta$  (down up cursor).
- Move to  $\mathbb{R}$  /  $\mathbb{R}$  using the  $\triangleright$  (right cursor) key.

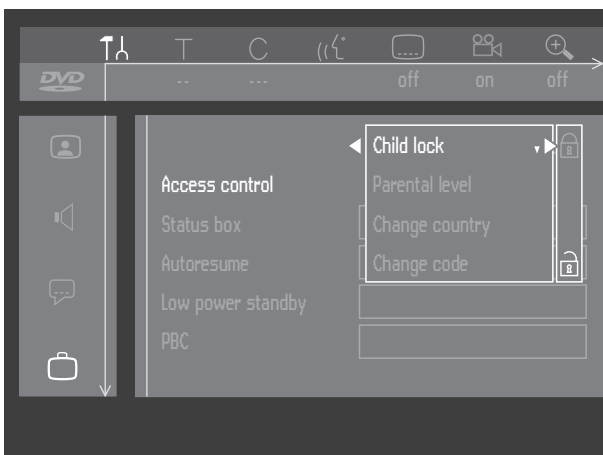

- Select  $\mathbb{R}$  using  $\nabla/\Delta$  (down up cursor).
- Press **OK** or  $\triangleleft$  (left cursor) to confirm and press **SYSTEM MENU** again to exit the menu.
  - ▶ Now unauthorized discs will not be played unless the 4-digit code is entered.
- Select  $\mathbb{R}$  to deactivate the Child Lock.

Note:

Reconfirmation of the 4-digit PIN code is necessary when:  
 The code is entered for the very first time (see above);  
 The code is changed (see 'Changing the 4-digit code');  
 The code is cancelled (see 'Changing the 4-digit code');  
 Both Child Lock and Parental Control are switched Off and the code is requested.

### Authorizing discs when Child Lock is activated

- Insert the disc.
  - ▶ The 'Child protect' dialog will appear. You will be asked to enter your secret code for 'Play once' or 'Play always'. If you select 'Play once', the disc can be played as long as it is in the recorder and the recorder is in the On position. If you select 'Play always', the disc will become Child safe (authorized) and can always be played even if the Child lock is set to 'On'.

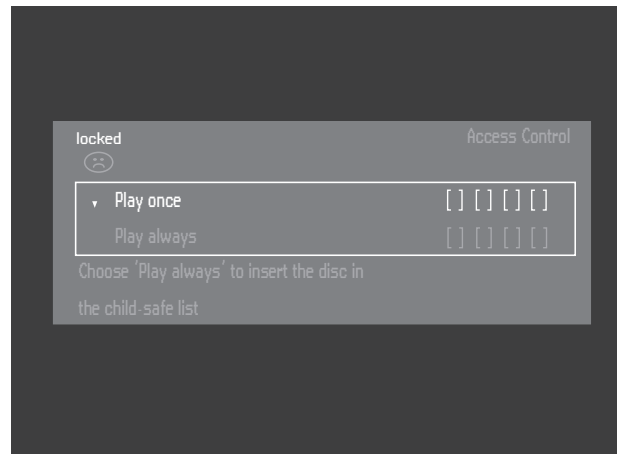

Note:

Double sided DVD discs may have a different ID for each side. In order to make the disc 'Child safe', each side has to be authorized.  
 Multi volume VCD disc may have a different ID for each volume. In order to make the complete set 'Child safe', each volume has to be authorized.

### Securing discs

- Insert the disc.
  - ▶ Playback starts automatically.
- Press **STOP** while  $\text{☺}$  is visible.
  - ▶  $\text{☹}$  will appear and the disc is now banned i.e. it is not Child safe any longer.

## Parental Level (DVD-Video only)

Movies on pre-recorded DVD discs may contain scenes not suitable for children. Therefore discs may contain 'Parental Control' information which applies to the complete disc or to certain scenes on the disc. These scenes are rated from 1 to 8 and alternative, more suitable scenes are available on the disc. Ratings are country dependent. The 'Parental Control' feature allows you to prevent discs from being played by your children or to have certain discs played with alternative scenes.

### Activating/Deactivating Parental Control

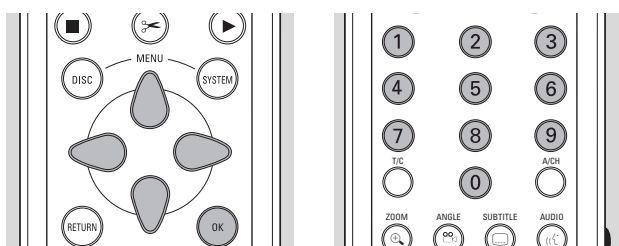

- Select '**Access control**' in the features menu using  $\nabla/\Delta$  (down up cursor) and press  $\triangleright$  (right cursor).
- Enter your 4-digit PIN code using the digit keys **0-9**. If necessary enter the code a second time.
- Move to '**Parental level**' using  $\nabla/\Delta$  (down up cursor).
- Move to the Value Adjustment bar using  $\triangleright$  (right cursor).

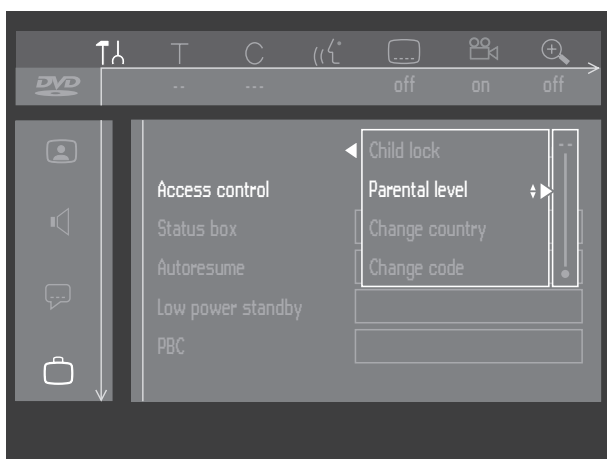

- Use the  $\nabla/\Delta$  (down up cursor) keys or the numerical keys **0-9** on the remote control to select a rating from 1 to 8 for the disc inserted.

*Rating 0 (displayed as '- -'):*

Parental Control is not activated. The disc will be played in full.

*Ratings 1 to 8 (1 = childsafe - 8 = adults only):*

The disc contains scenes not suitable for children. If you set a rating for the recorder, all scenes with the same rating or lower will be played. Higher rated scenes will not be played unless an alternative is available on the disc. The alternative must have the same rating or a lower one. If no suitable alternative is found, play will stop and the 4-digit code has to be entered.

- Press **OK** or  $\triangleleft$  (left cursor) to confirm and press **SYSTEM MENU** again to exit the menu.

## Country

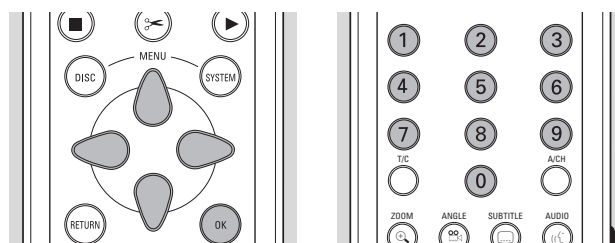

- Select '**Access control**' in the features menu using  $\nabla/\Delta$  (down up cursor) and press  $\triangleright$  (right cursor).
- Enter the four digit PIN code.
- Move to '**Change country**' using  $\nabla$  (down cursor).
- Press  $\triangleright$  (right cursor).

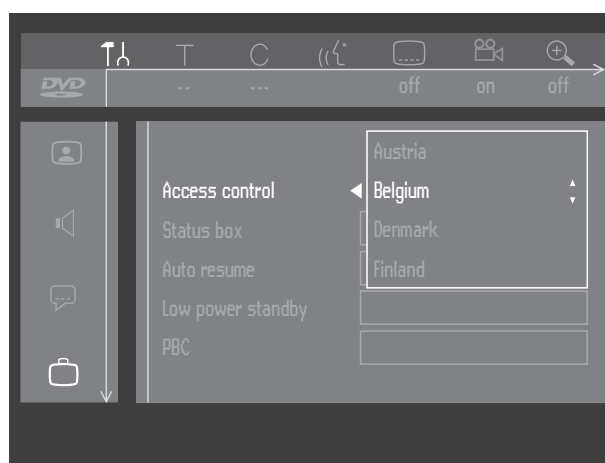

- Select a country using  $\nabla/\Delta$  (down up cursor).
- Press **OK** or  $\triangleleft$  (left cursor) to confirm and press **SYSTEM MENU** again to exit the menu.

## Changing the 4-digit code

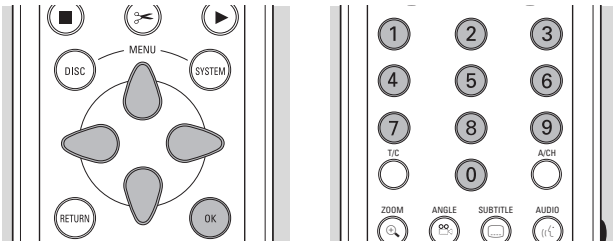

- Select '**Access control**' in the features menu using  $\nabla/\Delta$  (down/up cursor) and press  $\triangleright$  (right cursor).
- Enter the old code.
- Move to '**Change code**' using  $\nabla$  (down cursor).

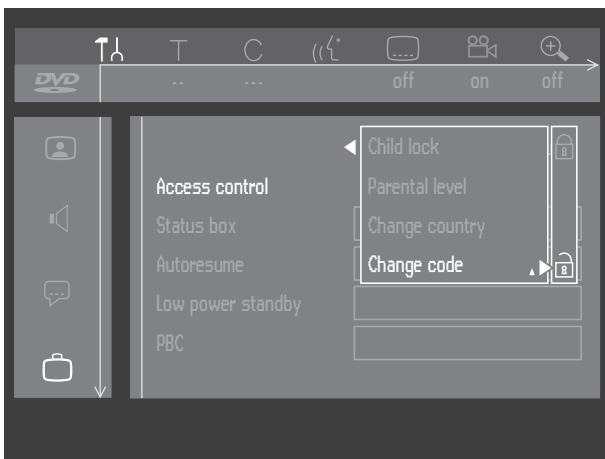

- Press  $\triangleright$  (right cursor).
- Enter the new 4-digit PIN code.
- Enter the code a second time and reconfirm with **OK**.
- Press **SYSTEM MENU** to exit the menu.

### Note:

If you forgot your code, press **■ STOP** four times while in the access control PIN code box and exit with **OK**. Access control is now switched off. You can then enter a new code as described above.

# Managing disc content

## Title settings

For each title on a DVD+RW or DVD+R disc the default settings can be changed to your personal preference in the title settings menu.

### Changing the title name

- In the Index Picture Screen, select the required title with  $\nabla\Delta$  (down up cursor).
- Press  $\triangleright$  (right cursor) to enter the title settings menu.



- Enter the new name. A name may contain a maximum of 64 characters.
- Use  $\triangleleft\triangleright$  (left right cursor) for the position of the characters. Use  $\nabla\Delta$  (down up cursor) to change characters.
- Use **SELECT** to toggle between capitals and lower case characters.
- Use **CLEAR** to erase a character.
- Confirm by pressing **OK**.

### Play full title

- In the Index Picture Screen, select the required title with  $\nabla\Delta$  (down up cursor).
- Press  $\triangleright$  (right cursor) to enter the title settings menu.
- Select 'Play full title'.

When this item is selected the title will be played in full, including hidden chapters. Follow the instructions on the screen. (See 'managing disc content - Favorite Scene Selection')

### Erasing a title

You may simply erase a title on DVD+RW by recording over it, but if you want to erase the whole title instantly, do the following:

- In the Index Picture Screen, select the required title with  $\nabla\Delta$  (down up cursor).
- Press  $\triangleright$  (right cursor) to enter the title settings menu.
- Select 'Erase this title'.
  - ▶ The message 'This will completely erase this title', 'Press OK to confirm' is shown.

- Press **OK** to confirm.
  - ▶ 'Erasing title...' is shown until the action is completed.
  - ▶ After the title has been erased, the Index Picture Screen will show an empty space instead. If there was an empty space in front of or behind this title, then these are combined into one empty space. Empty spaces of less than one minute will not be shown.

On DVD+R titles can also be erased but the space occupied cannot be used anymore. During finalisation erased titles are removed from the Index Picture Screen.

## Disc Info Screen

- When on the Index Picture Screen, press **■ STOP**.
  - ▶ You are now on Title 1.
- Press  $\Delta$  (up cursor).
  - ▶ You enter the Disc Info Screen.
- Press  $\nabla$  (down cursor) to exit the Disc Info Screen.

The Disc Info Screen contains the following information:

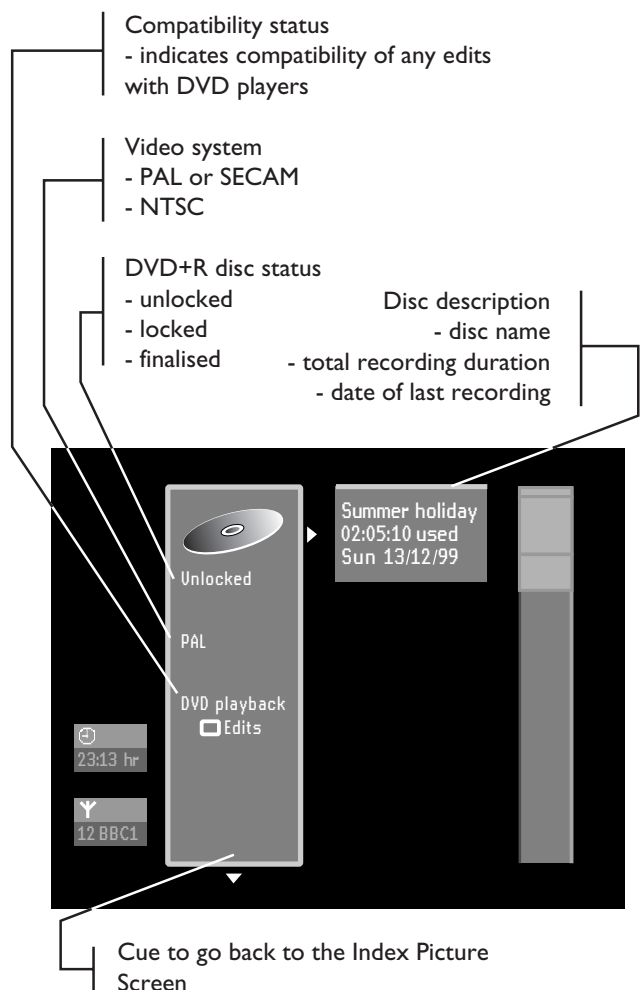

## Disc Settings

For each DVD+RW or DVD+R disc the settings can be changed to your personal preference in the disc settings menu.

- In the Disc Info Screen press  $\triangleright$  (right cursor).
  - You will now enter the 'disc settings' menu.

### Changing the Disc Name

- In the Disc Info Screen press  $\triangleright$  (right cursor).
  - You will now enter the 'disc settings' menu.

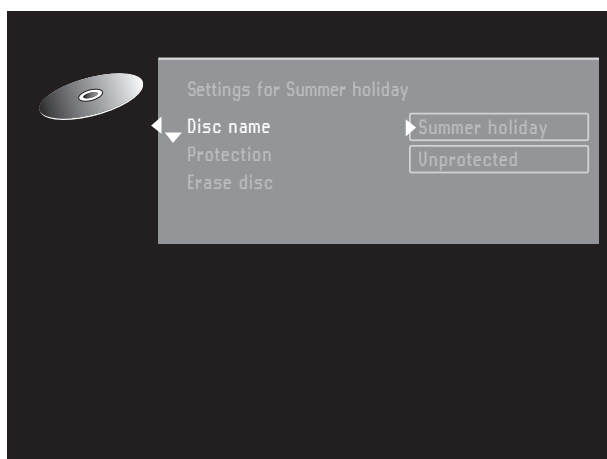

- Enter the new name. A name may contain a maximum of 64 characters.
- Use  $\triangleleft \triangleright$  (left right cursor) for the position of the characters. Use  $\nabla \triangle$  (down up cursor) to change characters.
- Use **SELECT** to toggle between capitals and lower case characters.
- Use **CLEAR** to erase a character.
- Confirm by pressing **OK**.

### Protection of recordings

- In the Disc Info Screen press  $\triangleright$  (right cursor).
  - You will now enter the 'disc settings' menu.
- Select **'Protection'** and press  $\triangleright$  (right cursor).
- Select **'Protected'** with  $\nabla \triangle$  (down up cursor).
- Press **OK** on the remote control to confirm.
  - No further changes can be made to the disc. It will also disable most title/disc settings options, as well as the complete edit menu.
  - Future editing is only possible after resetting the Protection feature to **'Unprotected'** again.

### Erasing a disc

This option is only available for DVD+RW discs that are not erase-protected.

- In the Disc Info Screen press  $\triangleright$  (right cursor).
  - You will now enter the 'disc settings' menu.
- Select **'Erase disc'** and press **OK**.
  - The message **'This will erase all titles'** is displayed.

- Press **OK** to confirm or  $\triangleleft$  (left cursor) to cancel.
  - **'Erasing disc'** is shown until the action is completed.
  - After the disc has been erased, the Index Picture Screen will show the free space on the disc.

### Finalising a DVD+R disc

While a DVD+RW disc can be played instantly on most DVD players, a DVD+R disc can be played only on the DVD recorder until it is finalised. After finalisation no changes can be made to the disc anymore.

- In the Disc Info Screen press  $\triangleright$  (right cursor).
  - You will now enter the 'disc settings' menu.

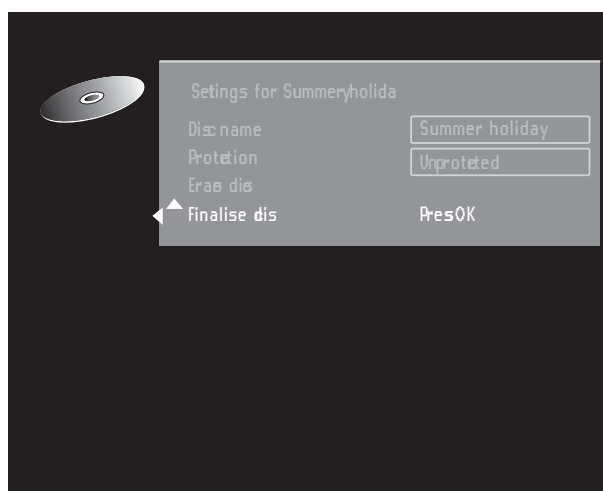

- Select **'Finalise disc'** and press **OK** to confirm.
  - **'Finalise disc'** is shown until the action is completed.
  - After finalisation the Index Picture Screen will appear.

If the DVD+R disc was recorded on a different brand of DVD recorder you may not be able to access the Disc Settings screen. In this case you can use the **'Finalise disc'** option in the features menu of the user preferences menu.

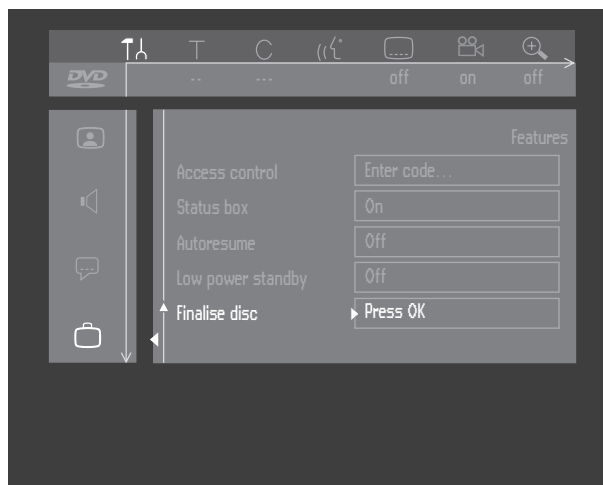

## Making your edits DVD-compatible

If one or more titles have been edited (see 'Favourite Scene Selection'), then the edits will play on your DVD recorder, but a DVD player may show the original versions instead of the edits. You can prepare your DVD+RW discs so that also a DVD player will show the edited version. This is not possible with DVD+R discs.

- If the Disc Settings menu shows the option '**Make edits DVD compatible**', select this option. If the menu does not show this option, then your DVD+RW disc is already compatible, and no conversion is needed.

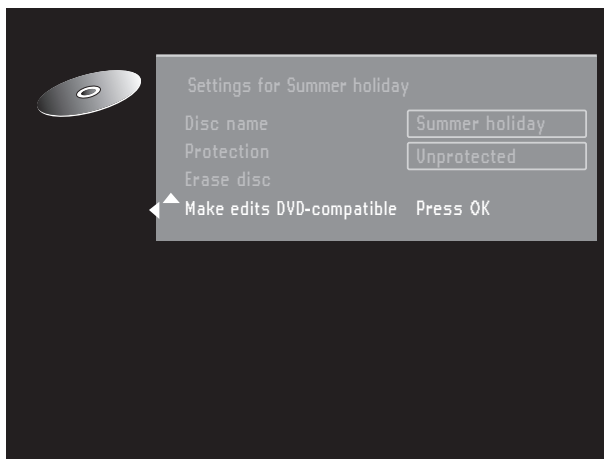

- Press **OK** on the remote control to confirm.
  - The messages '**This will take ...**' and '**Press OK to confirm**' will appear to indicate how long the action will take.
- Press **OK** on the remote control to confirm.
  - '**Processing...**' and a progress bar are shown until the action is completed.

## Favourite Scene Selection

The basic function of any edit operations is to improve accessibility and handling of your recordings. For instance: scenes you do not want to see during playback (e.g. commercials during a movie) can be marked as chapters and made hidden. During playback you will see your recording without the hidden chapters as one sequence.

*Note:*

*In between the scenes the picture may freeze for a short moment.*

Each title consists of chapters. With the FSS menu any chapter can be made hidden or made visible again. Normally, during recording, chapter markers are inserted automatically every five to six minutes (this setting can be changed in the record settings menu). After the recording is finished, you can manually add and remove chapter markers via the FSS menu. Both automatically generated and manually inserted chapter markers can be removed.

After editing, the modified version of a title is the default playback version. The original can be accessed via the '**Play full title**' option in the title settings menu. Other DVD players may still play the original. To guarantee that the edited version will play on these DVD players, choose '**Make edits DVD-compatible**' in the disc settings menu (only available on DVD+RW discs).

## Calling up the FSS menu

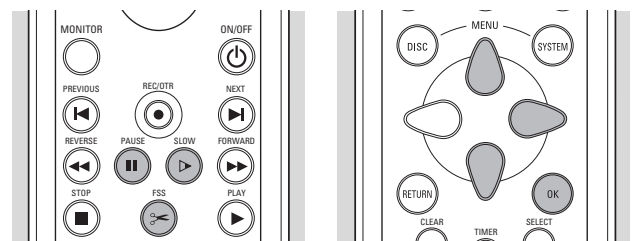

- Play the title you want to edit.
- Press the **FSS** key on the remote control.
- The video image is overlaid with a transparent edit menu. Title and chapter information appear in an information box at the top of the screen.

*Note:*

*The Favourite Scene Selection menu may disappear after about five minutes if you do not edit any information.*

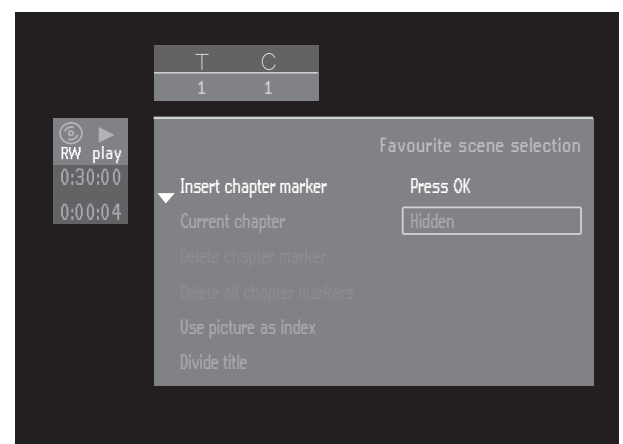

- Use **▽** or **△** (down up cursor) to toggle through the menu's functions.

## Inserting chapter markers

- In play mode press  **FSS** on the remote control, to call up the FSS menu.
- Select 'Insert chapter marker'.
- Press **OK** on the remote control to insert a marker.

The maximum number of chapter markers is 99.

When this maximum is reached the on-screen message 'Too many chapters' appears. You have to delete some, before inserting new chapter markers.

During recording you can add chapter markers by pressing  **FSS** on the remote control. The message 'Chapter marker inserted' will appear on the screen.

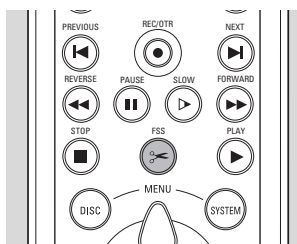

## Hiding chapters

Initially all chapters are visible. You can hide chapters or make them visible again on playback. In FSS mode however hidden chapters are displayed in a dimmed mode.

- In play mode press  **FSS** on the remote control to call up the FSS menu.

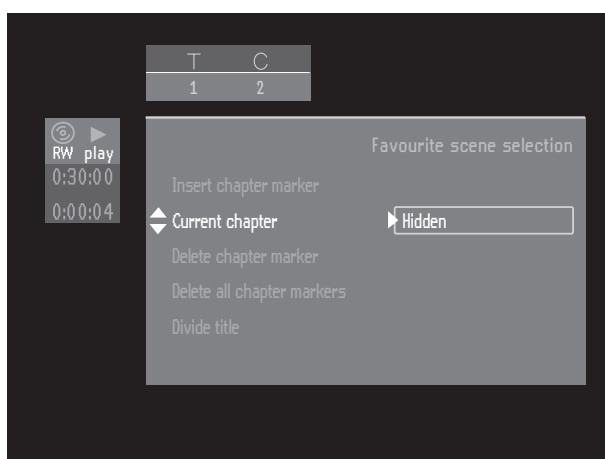

- Select 'Current chapter' with  $\nabla$  or  $\triangle$  (down/up cursor).
- Select 'Visible' or 'Hidden' with the  $\triangleright$  (right cursor) key.
- You can toggle between 'Visible' and 'Hidden' directly from any line in the FSS menu with the **SELECT** key on the remote control.

## Deleting chapter markers

You can combine a chapter with the previous chapter in the current title by deleting the chapter at the beginning of the current chapter.

- In play mode press  **FSS** on the remote control to call up the FSS menu.
- Select 'Delete chapter marker'.
- Press **OK** on the remote control to confirm  $\triangleright$  'Deleting marker' will appear.

You can delete all chapter markers (manually and automatically generated) in the current title.

- In play mode press  **FSS** on the remote control to call up the FSS menu.
- Select 'Delete chapter markers'.
- Press **OK** on the remote control to confirm  $\triangleright$  'Deleting markers' will appear.

## Changing the index picture

You can define the current video frame as a miniature picture to be used for this title's entry in the Index Picture Screen.

- In play mode press  **FSS** on the remote control to call up the FSS menu.
- Select 'New index picture'.
- You can use **II PAUSE** and/or  $\triangleright$  **SLOW** to accurately choose the desired picture.
- Press **OK** on the remote control to confirm.  $\triangleright$  'Updating menu' will appear.

## Dividing a title

On a DVD+RW disc you split one title into two separate titles. (On DVD+R this is not possible.)

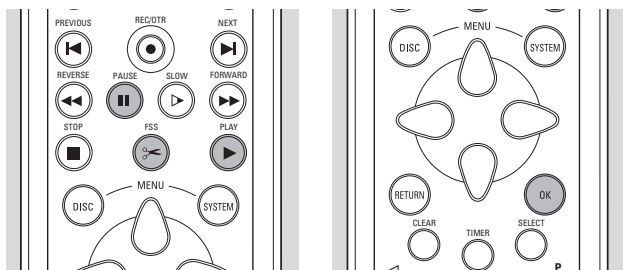

- On the Index Picture Screen, select the title you want to divide.
- Press ► **PLAY**.
- Go to the point where you want to divide the title and press **II PAUSE**.
- Press **FSS**.
  - The Favourite Scene Selection menu is shown.
- Select 'Divide title'.

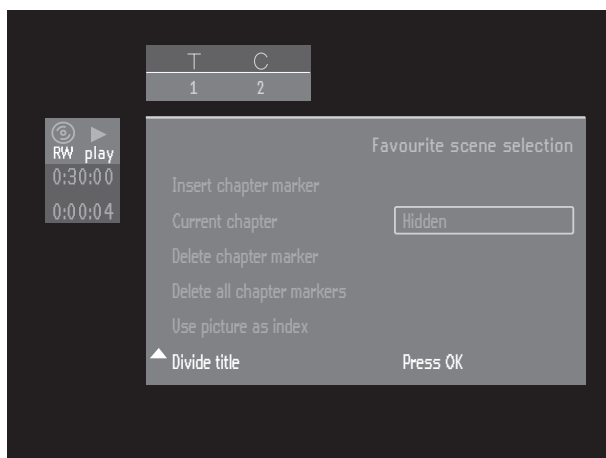

- Press **OK** on the remote control to confirm.
  - 'Dividing title . . .' is shown until the action is completed. This divide operation cannot be undone.

The Index Picture Screen will show two titles instead of one. Both will have the same name. If you want to change the name, you can do so in the title settings menu. For one of the two resulting titles, a new index picture is created.

If you want to divide one title into more than two titles, use the above procedure several times.

## Append recording

This function is only available on DVD+RW discs.

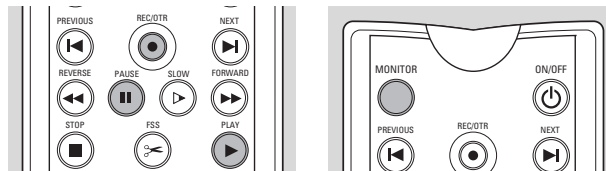

If you want to append a video recording to an earlier recorded title, do the following.

- On the Index Picture Screen, select the title to which you want to add a video recording.
- Press ► **PLAY**.
- At the point where you want to append the title press **II PAUSE**.
- To monitor the video input you may press **MONITOR**.
- Press **RECORD** (on the recorder) or **REC/OTR** (on the remote control).

The video recording will now be appended from this point. Video material beyond this point is overwritten. This may include titles following the current title.

Any remaining video material that is not overwritten, which may include the last part of the original title, is maintained. You can access these titles from the Index Picture Screen.



# Troubleshooting

If it appears that the DVD recorder is faulty, first consult this checklist. It may be that something has been overlooked. Under no circumstances attempt to repair the system yourself; this will invalidate the warranty. Look for the specific symptom(s). Then perform only the actions listed to remedy the specific symptom(s).

Symptom	Remedy
<b>The recorder does not respond to the remote control</b>	<ul style="list-style-type: none"><li>• The remote control may be configured for a second DVD recorder. Hold <b>SELECT+1</b> pressed simultaneously to revert to DVD recorder 1.</li><li>• Aim the remote control directly at the sensor on the front of the recorder.</li><li>• Avoid all obstacles which may interfere with the signal path.</li><li>• Inspect or replace the batteries.</li></ul>
<b>Keys on the DVD recorder do not work</b>	<ul style="list-style-type: none"><li>• The DVD recorder may still be in Virgin mode. See 'First time set-up: virgin mode'.</li><li>• Otherwise disconnect and reconnect the DVD recorder from the mains.</li><li>• If this does not solve the problem, check if the remote control still works. If so, the recorder is probably in trade mode. Disconnect the recorder from the mains and reconnect it while holding <b>▲ OPEN/CLOSE</b> and <b>■ STOP</b> pressed.</li></ul>
<b>No picture</b>	<ul style="list-style-type: none"><li>• Check if the TV set is switched on.</li><li>• Check the video connection.</li><li>• When the DVD recorder is connected to the TV set via SCART, you may not see the picture at the DVD recorder after selecting the correct programme number on your TV set when a timer recording takes place.</li><li>• This way, you can still view another device (e.g. a satellite receiver).</li><li>• To view the DVD recorder press TV/DVD on the remote control.</li></ul>
<b>Distorted picture distorted sound</b>	<ul style="list-style-type: none"><li>• Check the disc for fingerprints and clean with a soft cloth, wiping from centre to edge.</li><li>• Sometimes a small amount of picture distortion may appear. This is not a malfunction.</li></ul>
<b>Recorder does not play disc</b>	<ul style="list-style-type: none"><li>• Ensure the disc label is upwards and that the right disc type is inserted.</li><li>• Clean the disc.</li><li>• Check if the disc is defective by trying another disc.</li><li>• Check if the region code of the disc matches the region code of the recorder. (pre-recorded DVD discs only). See 'playing a pre-recorded DVD-Video disc'.</li><li>• Check if Child Lock is activated.</li></ul>
<b>Distorted sound from HiFi amplifier</b>	<ul style="list-style-type: none"><li>• Check to make sure that no audio connections are made to amplifier phono input.</li><li>• Check to make sure that analogue input of the amplifier is not connected to the digital output of the DVD recorder.</li></ul>
<b>Distorted or black and white picture with DVD or Video CD disc</b>	<ul style="list-style-type: none"><li>• The disc format is not according to the TV set used (PAL/NTSC).</li></ul>
<b>No audio at digital output</b>	<ul style="list-style-type: none"><li>• Check the digital connections.</li><li>• Check the settings menu to make sure that the digital output is set to on.</li><li>• Check if the audio format of the selected audio language matches your receiver capabilities.</li></ul>
<b>Recorder does not respond to all operating commands during playback of a DVD-Video disc</b>	<ul style="list-style-type: none"><li>• Some operations are not permitted by the disc. Refer to the instructions in the disc inlay.</li></ul>

<b>The recorder does not record timer programme</b>	<ul style="list-style-type: none"> <li>• Make sure that the recorder is switched to standby before the timer starts.</li> </ul>
<b>No new title can be recorded</b>	<ul style="list-style-type: none"> <li>• Check if the maximum number of titles has been reached (message: <b>'too many titles'</b> on screen). If so, delete a title next to a free space.</li> <li>• Check if the disc is write protected. If so, unlock the disc in the disc settings menu (message: <b>'Disc locked'</b> on screen).</li> <li>• Check if the (DVD+R) disc has been finalized. If so, no new titles can be recorded anymore.</li> </ul>
<b>Service codes on the display</b>	<ul style="list-style-type: none"> <li>• Clean the disc. The recording was most probably done correctly.</li> </ul>
<b>'Disc warning' message on screen</b>	<ul style="list-style-type: none"> <li>• A write error has occurred, but it could be corrected. No user action is required.</li> </ul>
<b>'Disc error' message on screen</b>	<ul style="list-style-type: none"> <li>• A write error has occurred from which the recorder could not recover. Inspect the disc and clean it if necessary (refer to 'Introduction - Cleaning discs' for cleaning instruction). Record (overwrite) again over the same part of the disc to see if the problem is solved</li> </ul>
<b>Disc errors</b>	<ul style="list-style-type: none"> <li>• A disc might be corrupted because of dust, scratches or fingerprints. If the disc cannot be accessed anymore, use the back-up disc erase procedure to repair it. Proceed as follows: <ol style="list-style-type: none"> <li>1. Clean the disc.</li> <li>2. Put disc in the drawer (do not close the tray).</li> <li>3. Press and hold <b>CLEAR</b> for several seconds until the tray closes.</li> </ol> </li> </ul>
<b>Two languages are 'mixed' when recording from a stereo VCR</b>	<ul style="list-style-type: none"> <li>• When the TV set does not automatically detect the dual-language signal, use left/right audio balance on the TV set to amplify the one or the other language.</li> </ul>
<b>The disc cannot be erased because the Index Picture Screen does not appear</b>	<ol style="list-style-type: none"> <li>1. Open the tray while leaving the disc in.</li> <li>2. Hold <b>CLEAR</b> pressed for around 5 seconds until the tray closes. The disc is technically not yet erased but you can start a new recording like on a blank disc.</li> </ol>
<b>The Index Picture Screen does not appear but the titles on the disc can still be played</b>	<ul style="list-style-type: none"> <li>• Take out the disc. Clear the disc. Insert the disc. Choose 'Adapt to own disc format' (See 'User Preferences - Features').</li> </ul>
<b>A DVD player shows the Index Picture Screen but does not react to the ► PLAY key</b>	<ul style="list-style-type: none"> <li>• Press <b>■ STOP</b> to exit the Index Picture Screen, then press <b>► PLAY</b>.</li> </ul>
<b>A DVD+RW disc does not play on a certain DVD player</b>	<ul style="list-style-type: none"> <li>• There are DVD Players that will not play recordings made with a DVD Recorder. With a special procedure the recorder will solve this problem for some players. Proceed as follows: <ol style="list-style-type: none"> <li>1. Put the disc in the drawer (do not close the tray)</li> <li>2. Press and hold the <b>2</b> key on the remote control for several seconds until the tray closes. The disc is now modified.</li> <li>3. If the change has no effect, you may perform the same procedure with the <b>3</b> key on the remote control.</li> </ol> <p><i>Note :</i>  <i>Modifying the disc can solve the problem for a specific player model, but playback in other DVD players may no longer be possible.</i>  <i>It is therefore recommended to use this procedure carefully and only when needed.</i></p> <ul style="list-style-type: none"> <li>• To revert the disc to the original state, follow the same procedure with the <b>1</b> key on the remote control</li> </ul> </li> </ul>

## Diagnosis programme

If the recorder is still faulty you can start the Diagnosis Programme in the recorder.

You can operate the Diagnosis Programme by following the instructions step by step.

### Instructions

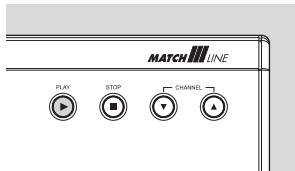

- Unplug the power cord of the recorder.
- Press the ► **PLAY** key and keep them pressed while you plug the recorder.
  - ▶ On the display the message 'BUSY' appears together with a counter. This counter indicates the termination of the test when zero is reached.
  - ▶ After a few minutes the message on the local display changes over from 'BUSY' to 'FAIL' or to 'PASS'.
  - ▶ If the message 'FAIL' appears on the display, there is apparently a failure in your recorder and your recorder should be repaired.
- Consult your dealer or the Philips Customer Care Centre for the nearest Service Repair Shop in your country. The phone number is given in your warranty booklet.
- If the message 'PASS' appears on the display, there is apparently no failure in your recorder, in this case the failure can be caused by incorrect interpretation of the operating instructions or a wrong disc is used or your recorder is not correctly connected. In this case you should consult your dealer or the Philips Customer Care Centre for further assistance in solving the problem.
- If the problem remains, then consult your Philips Customer Care Centre.

## System limitations

DVD+RW and DVD+R discs may not play on certain DVD Video players.

A DVD+RW video disc that has been recorded on a different type or brand of recorder can be played, but may not provide all features commonly available to DVD+RW discs, such as the on-screen disc bar, the disc settings menu, the title settings menu, and editing. Refer to 'Adapt disc format'. If the disc is write-protected, the status cannot be changed.

When using manual recording, the DVD recorder will warn before adapting the format of the disc or removing non-video data. When using timer recording however, the DVD recorder will always start to record, unless the disc is write-protected. Menus, edits and other data recorded on a different device (e.g. a PC) may be lost.

Because of the Variable Bit Rate, a title map take up less or more space than the overwritten title, even though the duration is the same. As a result, a part of the original title may remain, or a part of the next title may be lost. The maximum deviation is five minutes.

After a power interruption during recording, the Index Picture Screen will may not match with the actual video content on the disc. The last recorded title may be lost.

# Glossary

This section explains most important terms, abbreviations, and acronyms used in this document.

<b>Term</b>	<b>Explanation</b>
<b>AC-3</b>	Audio Coding 3, also known as Dolby Digital. Multi-channel digital audio compression system from Dolby Labs.
<b>A/V</b>	Audio/Video
<b>Chapter</b>	A part of a title.
<b>Disc Bar</b>	A graphical representation of the contents of a (DVD+RW) disc.
<b>Disc Pointer</b>	An arrow indicating the current playback/recording position on the DVD+RW disc, displayed on the 'disc bar'.
<b>DTS</b>	Digital Theater System. A high-end Multi-channel audio compression format.
<b>DV</b>	Digital Video. A camcorder format for high-quality video, different from MPEG. It is converted into MPEG 2 Video when recorded on DVD+RW
<b>DVD</b>	Digital Versatile Disc
<b>DVD+R</b>	DVD+Recordable. The write-once disc standard used by the DVD recorder.
<b>DVD+RW</b>	DVD+ReWritable. One of the disc standards used by the DVD recorder.
<b>EasyLink</b>	If your TV set and your video recorder are equipped with this feature, they can exchange information to adjust certain settings to each other, such as the TV channel order and other user preferences.
<b>FSS</b>	Favorite Scene Selection. see 'Managing disc content'.
<b>i.LINK</b>	Also known as 'FireWire' and 'IEEE 1394'. A cable for transfer of high-bandwidth digital signals, as used by Digital Video camcorders.
<b>Index Picture Screen</b>	A screen that gives an overview of a DVD+RW disc, with 'index pictures' that each represent a recording.
<b>MPEG</b>	Motion Picture Experts Group. A collection of compression systems for digital audio and video.
<b>NEXTVIEW Link</b>	A system that enables easy programming of a video recorder via a TV set. Also see EasyLink.
<b>NICAM</b>	System for reception of digital stereo TV sound.
<b>NTSC</b>	See TV system.
<b>OSD</b>	On-screen Display. The 'user interface' by which you can control the DVD recorder via the TV screen.
<b>OTR</b>	One-Touch Recording. With this feature you can easily start a recording (by pushing just one button) and select the switch-off time in intervals of 30 minutes.

<b>PAL</b>	See TV system.
<b>PBC</b>	Playback Control. A special feature on a VCD 2.0 or Super VCD disc that enables interactive use.
<b>PCM</b>	Pulse Code Modulation. A digital audio encoding system.
<b>PDC</b>	Program Delivery Control
<b>RGB</b>	Red-Green-Blue. A top-quality video connection where red, green and blue components of a video signal are carried through separate wires.
<b>SCART cable</b>	Also known as Euro-AV cable. This standard cable is an easy way to connect various AV devices and televisions. In addition to audio and video it can carry control signals.
<b>SECAM</b>	See TV system.
<b>S-video</b>	Sometimes also called S-VHS or Super-VHS. A high-quality video connection standard.
<b>SVCD</b>	Super Video Compact Disc.
<b>Title</b>	It is the name given to the unit of recording on the disc. A title, typically, represents one recording.
<b>TruSurround</b>	A system for simulating Multi-channel sound reproduction via a two-channel set-up, by SRS Labs, Inc.
<b>TV system</b>	There are various systems for transmitting television signals, for example PAL, PAL-I, PAL-BG, SECAM, SECAM-DK, NTSC, etc. The TV system is country dependant.
<b>VCD</b>	Video Compact Disc
<b>VCR</b>	Video Cassette Recorder
<b>VIDEO Plus+</b>	A system by which you can easily program a timer recording by entering a nine-digit VideoPlus+ number found next to the programme description in most TV guides.
<b>VPS</b>	Video Programming System

## Using your DVD recorder remote control with your TV set

Your DVD recorder remote control can transmit several commands to TV sets of different brands. The following keys will always operate the TV set:

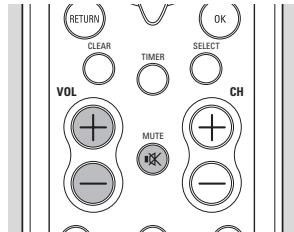

- **VOL+** increase TV volume
- **VOL -** decrease TV volume
- **MUTE** mute TV

Some other keys normally operate the DVD recorder, but will operate the TV set when you keep the button on the side of the remote control pressed:

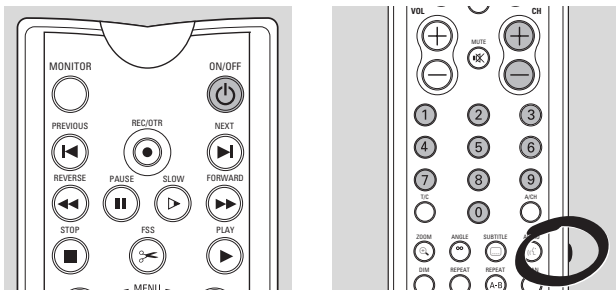

- **CH +** next TV programme number
- **CH -** previous TV programme number
- **0 - 9** choose TV channel
- **⏻** switch TV set to standby

If your TV set does not respond to the remote control, you can re-programme your remote control. Below you will find a list of all available remote control codes for various TV brands. The following procedure re-programmes your remote control:

- Look up the set-up code for your TV set in the code list below.
- Press and hold the **RETURN** and **SELECT** key simultaneously for at least 3 seconds.
- Release both keys.
- Enter, within 30 seconds, the correct three-digit code with the digit keys **0-9**.
- If the selected code does not work with your TV set, or if the brand of your TV set is not in the list, try out the codes one after the other.

### Alternative procedure:

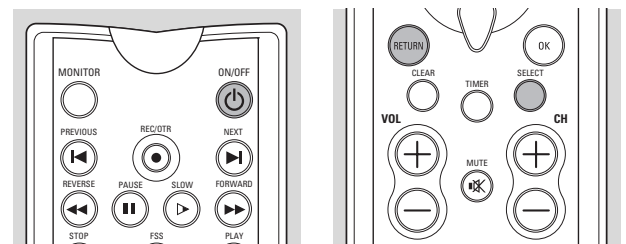

- Switch on your television set.
- Press and hold the **RETURN** and **SELECT** key simultaneously for at least 3 seconds.
- Release both keys.
- Point the remote control to your TV set.
- Press and hold the **⏻** **STANDBY** key.
  - Your TV set switches off when the right code is found.
- When your TV set switches off, immediately release the **⏻** **STANDBY** key.
  - Your remote control is now re-programmed.
- This complete procedure may take up to 2 minutes.

### Remote control set-up codes for television

AOC . . . . .	046, 057	BSR . . . . .	321	CXC . . . . .	207	. . . . .	172, 181, 193, 478
Acura . . . . .	036	BTC . . . . .	245	Candle . . . . .	057, 083	Cybertron . . . . .	245
Admiral . . . . .	120, 490	Bang & Olufsen . . . . .	592	Carnivale . . . . .	057	Daewoo . . . . .	119, 046, 401, 478,
Adyson . . . . .	244	Basic Line . . . . .	036, 245	Carrefour . . . . .	063	. . . . .	036, 064, 066
Aiko . . . . .	119	Baur . . . . .	064, 037, 581	Carver . . . . .	081	Dainichi . . . . .	245
Akai . . . . .	057	Baysonic . . . . .	207	Cascade . . . . .	036	Dansai . . . . .	064
Akura . . . . .	245, 291	Beaumark . . . . .	205	Cathay . . . . .	064	Dayton . . . . .	036
Alaron . . . . .	206, 243	Beko . . . . .	397	Celebrity . . . . .	027	Daytron . . . . .	046
Alba . . . . .	064, 036, 245, 063, 398	Belcor . . . . .	046	Centurion . . . . .	064	Decca . . . . .	064, 099
Allorgan . . . . .	321	Bell & Howell . . . . .	181	Cimline . . . . .	036	Denon . . . . .	172
America Action . . . . .	207	Beon . . . . .	064	Cineral . . . . .	478, 119	Dixi . . . . .	036, 064
Amplivision . . . . .	244	Binatone . . . . .	244	Citizen . . . . .	083, 057, 066, 087,	Dual Tec . . . . .	244
Amstrad . . . . .	198, 398, 036, 064	Blaupunkt . . . . .	581	. . . . .	119	Dumont . . . . .	044, 046, 097
Anam . . . . .	207, 036	Blue Sky . . . . .	245	Clarivox . . . . .	064	Electroband . . . . .	027
Anitech . . . . .	036	Blue Star . . . . .	309	Clatronic . . . . .	397	Elin . . . . .	064
Arcam . . . . .	243, 244	Boots . . . . .	244	Concerto . . . . .	083	Elite . . . . .	245, 347
Asuka . . . . .	245	Bradford . . . . .	207	Condor . . . . .	347, 397	Elta . . . . .	036
Atlantic . . . . .	233	Brandt . . . . .	136	Contec . . . . .	036, 063, 207, 243	Emerson . . . . .	263, 207, 205, 206,
Audiosonic . . . . .	064, 136	Britannia . . . . .	243	Craig . . . . .	207	. . . . .	490, 309, 066, 046, 181
Audiovox . . . . .	119, 207, 478	Brockwood . . . . .	046	Crosley . . . . .	081	Envision . . . . .	057
Autovox . . . . .	233	Broksonic . . . . .	263, 490	Crown . . . . .	397, 036, 064, 066,	Erres . . . . .	039, 064
BPL . . . . .	309	Bush . . . . .	064, 398, 245, 036, 063,	. . . . .	207, 445	Expert . . . . .	233
		. . . . .	309, 321, 401	Crystal . . . . .	458	Ferguson . . . . .	136, 064
		CCE . . . . .	064, 244	Curtis Mathes . . . . .	087, 057, 066,	Fidelity . . . . .	243
		CS Electronics . . . . .	243	. . . . .	074, 078, 081, 083, 120,	Finlux . . . . .	064, 132, 097, 099, 206

- Firstline . . . 348, 036, 243, 244, . . . . . 321  
 Fisher . . . . . 244, 181, 397  
 Flint . . . . . 482  
 Formenti . . . . . 347, 064  
 Frontech . . . . . 458, 291  
 Fujitsu . . . . . 206, 099, 233  
 Funai . . . . . 321, 198, 206, 207, 291  
 Futuretech . . . . . 207  
 GE . . . . . 048, 074, 078, 205, 478, . . . . . 120, 309  
 GEC . . . . . 099, 064, 244  
 GPM . . . . . 245  
 Geloso . . . . . 036  
 Genexxa . . . . . 245  
 Gibraltar . . . . . 044, 046, 057  
 GoldStar . . . . . 064, 046, 057, 205, . . . . . 244, 083, 136  
 Goodmans . . . . . 064, 099, 206, . . . . . 398, 063, 244, 401  
 Gorenje . . . . . 397  
 Gradiente . . . . . 083, 080  
 Granada . . . . . 064, 099, 244  
 Grandin . . . . . 309  
 Grundig . . . . . 097, 581, 064  
 Grunpy . . . . . 206, 207  
 HCM . . . . . 036, 309  
 Hallmark . . . . . 205  
 Hanseatic . . . . . 064, 347  
 Harley Davidson . . . . . 206  
 Harman/Kardon . . . . . 081  
 Harvard . . . . . 207  
 Hinari . . . . . 036, 063, 064, 245, . . . . . 206  
 Hisawa . . . . . 309, 482  
 Hitachi . . . . . 136, 071, 172, 244, . . . . . 063, 083, 132  
 Huanyu . . . . . 243, 401  
 Hypson . . . . . 291, 064, 309  
 ICE . . . . . 244, 291, 398  
 ICeS . . . . . 245  
 ITS . . . . . 398  
 Imperial . . . . . 445, 397  
 Indiana . . . . . 064  
 Infinity . . . . . 081  
 Inno Hit . . . . . 099  
 Innova . . . . . 064  
 Inteq . . . . . 044  
 Interfunk . . . . . 064  
 Intervision . . . . . 064, 129, 244, 291  
 Isukai . . . . . 245  
 JBL . . . . . 081  
 JCB . . . . . 027  
 JVC . . . . . 080, 063, 398, 680  
 KEC . . . . . 207  
 KTV . . . . . 207, 244, 057, 066  
 Kaisui . . . . . 245, 244, 036, 243, 309  
 Kamp . . . . . 243  
 Kapsch . . . . . 233  
 Kawasho . . . . . 243  
 Kendo . . . . . 064  
 Kenwood . . . . . 057, 046  
 Kingsley . . . . . 243  
 Korpel . . . . . 064  
 Koyoda . . . . . 036  
 LG . . . . . 083  
 LXI . . . . . 181, 074, 081, 183, 205  
 Leyco . . . . . 099, 064, 291, 321  
 Liesenk & Tter . . . . . 064  
 Luma . . . . . 233  
 Luxman . . . . . 083  
 M Electronic . . . . . 132, 244, 036, . . . . . 064, 136, 401  
 MGA . . . . . 177, 046, 057, 205  
 MTC . . . . . 087, 057, 046, 083, 243  
 Magnadyne . . . . . 129  
 Magnafon . . . . . 129  
 Magnavox . . . . . 081, 057, 063, 206  
 Manesth . . . . . 347, 244, 291  
 Marantz . . . . . 064, 081, 057  
 Mark . . . . . 064  
 Matsui . . . . . 036, 064, 244, 398, 062, . . . . . 063, 099, 321  
 Matsushita . . . . . 277, 677  
 Mediator . . . . . 039, 064  
 Megatron . . . . . 172, 205  
 Memorex . . . . . 205, 036, 083, 177, . . . . . 181, 277, 490  
 Midland . . . . . 044, 066, 074, 078  
 Minerva . . . . . 097, 581  
 Minutz . . . . . 048  
 Mitsubishi . . . . . 063, 135, 177, 205, . . . . . 046, 120  
 Mivar . . . . . 243  
 Motorola . . . . . 120  
 Multitech . . . . . 036, 129, 207, 243, . . . . . 244  
 NAD . . . . . 183, 193, 205  
 NEC . . . . . 057, 063, 046, 083, 482  
 NEI . . . . . 064, 458  
 NTC . . . . . 119  
 Neckermann . . . . . 064, 581  
 Nesco . . . . . 206  
 Netsat . . . . . 064  
 Nikkai . . . . . 064, 062, 245, 099, 243, . . . . . 291  
 Nikko . . . . . 205, 057, 119  
 Nobliko . . . . . 129  
 Nordmende . . . . . 136  
 Onwa . . . . . 207  
 Optimus . . . . . 277, 193, 181, 677  
 Optonica . . . . . 120, 192  
 Orion . . . . . 321, 490, 064, 206, 263, . . . . . 347, 348  
 Osaki . . . . . 099, 244, 245, 291  
 Oso . . . . . 245  
 Osume . . . . . 099  
 Otto Versand . . . . . 064, 037, 063, . . . . . 244, 347, 581  
 Palladium . . . . . 397, 445  
 Panama . . . . . 244, 291  
 Panasonic . . . . . 078, 277, 677  
 Pathe Cinema . . . . . 347, 243  
 Pausa . . . . . 036  
 Penney . . . . . 074, 087, 057, 048, . . . . . 205, 078, 066, 046, . . . . . 083, 183  
 Perdio . . . . . 347  
 Philco . . . . . 172, 046, 057, 081, 490  
 Philips . . . . . 064, 039, 081, 401, 581  
 Phonola . . . . . 064, 039  
 Pilot . . . . . 046, 057, 066  
 Pioneer . . . . . 136, 193  
 Portland . . . . . 046, 066, 119  
 Prism . . . . . 078  
 Profex . . . . . 036  
 Proline . . . . . 348  
 Proscan . . . . . 074  
 Protech . . . . . 064, 129, 036, 458, . . . . . 244, 291, 445  
 Proton . . . . . 205  
 Pulsar . . . . . 044, 046  
 Pye . . . . . 039  
 Quasar . . . . . 078, 277, 192, 677  
 Quelle . . . . . 064, 097, 037, 581  
 Questa . . . . . 063  
 R-Line . . . . . 064  
 RBM . . . . . 097  
 RCA . . . . . 074, 046, 078, 117, 120  
 Radio Shack . . . . . 192, 207, 057, . . . . . 205, 066, 181, 046, . . . . . 074, 083  
 Radiola . . . . . 064, 039  
 Rank Arena . . . . . 063  
 Realistic . . . . . 192, 207, 181, 057, . . . . . 066, 205, 046, 083  
 Revox . . . . . 064  
 Rex . . . . . 233, 291  
 Rhapsody . . . . . 243  
 Roadstar . . . . . 036, 291, 245, 445  
 Runco . . . . . 044, 057  
 SBR . . . . . 039, 064  
 SEG . . . . . 244, 063, 291  
 SEI . . . . . 129, 037, 321  
 SKY . . . . . 064  
 SSS . . . . . 046, 207  
 Saba . . . . . 136  
 Saisho . . . . . 036, 291, 458  
 Sambers . . . . . 129  
 Sampo . . . . . 057, 066  
 Samsung . . . . . 064, 046, 205, 244, . . . . . 291, 397, 036, 057, . . . . . 066, 083, 087, 117  
 Samsux . . . . . 066  
 Sandra . . . . . 243  
 Sansei . . . . . 478  
 Sansui . . . . . 490  
 Sanyo . . . . . 181, 063, 099  
 Schneider . . . . . 064, 245, 398  
 Scimitsu . . . . . 046  
 Scotch . . . . . 205  
 Scott . . . . . 263, 046, 205, 206, 207  
 Sears . . . . . 181, 083, 183, 074, 081, . . . . . 198, 205, 206  
 Seleco . . . . . 233  
 Semivox . . . . . 207  
 Semp . . . . . 183  
 Sentra . . . . . 062  
 Sharp . . . . . 120, 192, 063, 066  
 Shogun . . . . . 046  
 Shorai . . . . . 321  
 Siarem . . . . . 129  
 Siemens . . . . . 581, 064  
 Silver . . . . . 063  
 Sinudyne . . . . . 129, 037, 321  
 Sonoko . . . . . 036, 064  
 Sontec . . . . . 064  
 Sony . . . . . 037, 063, 027  
 Soundesign . . . . . 205, 206, 207  
 Soundwave . . . . . 064, 445  
 Squareview . . . . . 198  
 Standard . . . . . 244, 245, 036  
 Starlite . . . . . 207  
 Stern . . . . . 233  
 Sunkai . . . . . 321, 348  
 Supra . . . . . 083  
 Supreme . . . . . 027  
 Susumu . . . . . 245  
 Sylvia . . . . . 081, 057  
 Symphonic . . . . . 198  
 Sysline . . . . . 064  
 TMK . . . . . 083, 205  
 Tandy . . . . . 245, 099, 244, 120  
 Tashiko . . . . . 063, 244  
 Tatung . . . . . 099, 244, 064  
 Tec . . . . . 244  
 Technema . . . . . 347  
 Technics . . . . . 078, 277, 677  
 Technol Ace . . . . . 206  
 Techwood . . . . . 078, 083  
 Teknika . . . . . 081, 206, 207, 046, . . . . . 066, 119, 083, 087, 177  
 Telefunken . . . . . 136, 083  
 Telemeister . . . . . 347  
 Teletech . . . . . 036  
 Teleton . . . . . 233, 063, 244  
 Tensai . . . . . 245, 321, 347  
 Texet . . . . . 243, 245  
 Thomson . . . . . 136  
 Thorn . . . . . 064, 062, 099  
 Tomashi . . . . . 309  
 Toshiba . . . . . 062, 183, 063, 097, . . . . . 087, 181  
 Totevision . . . . . 066  
 Uher . . . . . 233, 347  
 Ultravox . . . . . 129  
 Universum . . . . . 132, 064, 291, 397  
 Vector Research . . . . . 057  
 Vestel . . . . . 064  
 Victor . . . . . 080  
 Videotechnic . . . . . 244  
 Vidikron . . . . . 081  
 Vidtech . . . . . 046, 063, 205  
 Vision . . . . . 347  
 Waltham . . . . . 244  
 Wards . . . . . 081, 192, 205, 046, . . . . . 048, 057, 083, 206  
 Watson . . . . . 347, 064  
 Watt Radio . . . . . 129  
 Wega . . . . . 063  
 White Westinghouse . . . . . 347, . . . . . 064, 243, 490  
 Yamaha . . . . . 046, 057  
 Yoko . . . . . 244, 064, 291, 458  
 Zanussi . . . . . 233  
 Zenith . . . . . 044, 119, 490

Philips Customer Care Centers

Austria  
tel: 43-0810 001 203

Belgium  
tel: 32-2-070 222 303

Denmark  
tel: 808 82 814

Finland  
tel: 358-09-6158 0250

France  
tel: 33-1-825 889 789

Germany  
tel: 49-0-180-535 6767

Greece  
tel: 30-0-0800-3122 1280

Ireland  
tel: 353-1-7640292

Italy  
tel: 800-820026 (Toll Free)

Luxembourg  
tel: 352-404061215

Netherlands  
tel: 0900-8406

Norway  
tel: 22-748 250

Portugal  
tel: 352-1-4163063

Spain  
tel: 34-902-113 384

Sweden  
tel: 08 5985 2250

Switzerland  
tel: 0844 800 544

United Kingdom  
tel: 44-0-208 665 6350

Poland  
tel: 48-22-571 0571





# Notes

---

# Specifications

## DISC FORMATS SUPPORTED

Disc type	Playback	Recording
DVD+RW	•	•
DVD+R	•	•
DVD-RW (Video mode)	•	—
DVD-R	•	—
DVD-Video	•	—
SVCD	•	—
Video CD	•	—
Audio CD	•	—
CD-R	•	—
CD-RW	•	—

## RECORDABLE DISC FORMATS

Medium	DVD+RW: Phase-Change ReWritable	
	DVD+R: dye-based	
Diameter	12 cm	
Capacity (single side)	4.7 Gbyte	
Recording time	HQ 60'	9.72 Mbit/s
	SP 120'	5.07 Mbit/s
	LP 180'	3.38 Mbit/s
	EP 240'	2.54 Mbit/s

## TV STANDARD

	PAL/SECAM	NTSC
Scan Frequency	50Hz	60Hz
Number of lines	625	525
Playback	•	•
Recording	•	•
Internal tuner	•	—

## VIDEO FORMAT

Digital Compression	MPEG2 for DVD MPEG1 for VCD
---------------------	--------------------------------

## VIDEO RESOLUTION

	50Hz	60Hz
DVD-Video/DVD+RW(HQ/SP)		
-Horiz. Resolution	720 pixels <sup>1</sup>	720 pixels <sup>1</sup>
-Vertical Resolution	576 lines	480 lines
DVD+RW (LP/EP)		
-Horiz. Resolution	360 pixels <sup>2</sup>	360 pixels <sup>2</sup>
-Vertical Resolution	576 lines	480 lines
VCD		
-Horiz. Resolution	352 pixels	352 pixels
-Vertical Resolution	288 lines	288 lines

<sup>1</sup> equivalent to 500 lines on your TV

<sup>2</sup> equivalent to 250 lines on your TV

## VIDEO PERFORMANCE

DA Converter	10-bit
AD Converter	9-bit
Signal handling	Components
Video Output	1 Vpp into 75 Ohm
S-video Output	Y: 1 Vpp into 75 Ohm C: 0.300 Vpp into 75 Ohm
RGB Output	0.7 Vpp into 75 Ohm

## AUDIO FORMAT

Compressed Digital	Playback	Recording
-Dolby Digital (AC-3)	Multi-channel	2-channel
-DTS	Multi-channel	—
-MPEG1	2-channel	—
SPdif	2-channel	—
-PCM	16, 20, 24 bit fs 48 kHz	—

## AUDIO PERFORMANCE

DA Converter	24-bit	
AD Converter	16-bit	
DVD	fs 96 kHz	4 Hz - 44 kHz
	fs 48 kHz	4 Hz - 22 kHz
Video CD	fs 44.1 kHz	4 Hz - 20 kHz
Audio CD	fs 44.1 kHz	4 Hz - 20 kHz
Signal-Noise (1kHz)	105 dB	
Dynamic Range (1kHz)	100 dB	
Crosstalk (1kHz)	110 dB	
Distortion/Noise (1kHz)	90 dB	

## FRONT CONNECTIONS

i.LINK DV	IEEE 1394 4-pin
S-video Input	Hosiden 4-pin*
Video Input	Cinch (yellow)*
Audio Left/Right Input	Cinch (white/red)*

## REAR CONNECTIONS

SCART 1	CVBS, S-video/RGB-out, Decoder
SCART 2	CVBS, S-video/RGB-in, Decoder
S-video Input	Hosiden 4-pin
S-video Output	Hosiden 4-pin
Video Input	Cinch (yellow)*
Video Output	Cinch (yellow)*
Audio Left/Right Input	Cinch (white/red)*
Audio Left/Right Output	Cinch (white/red)*
Digital Audio Output	1 coaxial <sup>1</sup> , 1 optical IEC958 for CDDA / LPCM IEC1937, Dolby Digital, DTS
RF Antenna Input	Coaxial 75 ohms
RF TV Output	Coaxial 75 ohms
Mains	Standard (IEC type)

\* gold-plated

## USER INTERFACE

OSD Languages	English, French, German, Dutch, Spanish, Italian, Swedish
---------------	---

## PROGRAMMING

Number of events	6; 1 month; Daily/Weekly
Programming mode	OTR, Remote
Record control and transmitter identification	PDC, VPS
Timer programming	Manual, VIDEO Plus+, NEXTVIEW Link

## DISC RECORDING

- Safe Record	
- Direct Record	
- One-Touch Record (OTR)	
- Append	
- Divide	
- Erase	
- Automatic/Manual Chapter Marker insertion	
- Disc write lock	
- Favorite Scene Selection	
- Index Picture Screen	
- Custom Index Pictures	
- Automatic/Manual Audio Recording Level	

## DISC PLAYBACK

- Auto Resume (20 discs)	
- Play / Stop / Pause	
- Fast Forward/Backward (3 speeds)	
- Step Forward/Backward	
- Slow (3 speeds)	
- Title / Track Select	
- Next / Previous Title / Track / Chapter	
- Repeat (Chapter / Title / All) or (Track / All)	
- A-B Repeat	
- Intro Scan	
- Perfect Still with digital multi-tap filter	
- Zoom (x1,33, x2, x4) with picture enhancement	
- Pan	

## GENERAL FUNCTIONALITY

- 3D sound (SRS TruSurround)	
- Beep Feedback for Remote Control	
- Backup Presets & Timer Events: 1 year	
- Backup Clock & Calendar: 7 hrs	
- Time & Date Download	

## POWER SUPPLY

Power Inlet	220-240 V, 50/60 Hz
Power consumption	Operation 33 W Low-power Standby 3 W

## CABINET

Dimensions (W x H x D)	435 x 110 x 330 mm
Net Weight	8.8 kg
Front Panel	3 mm Aluminum

## REMOTE CONTROL

- Universal remote for control of main TV functions	
---	--

---

type no. of product • Numéro de série du produit

**DVDR 985**

---

Date of purchase • Date d'achat • Kaufdatum • Koopdatum • Fecha de compra •  
Data da compra • Data di acquisto • Købsdato • Kjøpedato • Inköpsdato • Ostopäivä

day • Jour    month • Mois    year • Année **20**

---



The products and services described herein are not necessarily available in all countries

Dealer's name, address and signature • Nom, adresse et signature du revendeur • Name,  
Anschrift und Unterschrift des Händlers • Naam, adres en handtekening van de  
handelaar • Nombre, dirección y firma del distribuidor • Nome, indirizzo e firma  
del fornitore • Nome, morada e assinatura do vendedor • Forhandlerens navn, adresse  
og underskrift • Återförsäljarens namn, adress och namnteckning • Myyjän nimi,  
osoite ja allekirjoitus

Due to continuous product improvements this document is subject to change without notice.